

Panasonic

Telephone Answering System
with Facsimile

KX-F280

Model No. **KX-F280C**

Operating Instructions

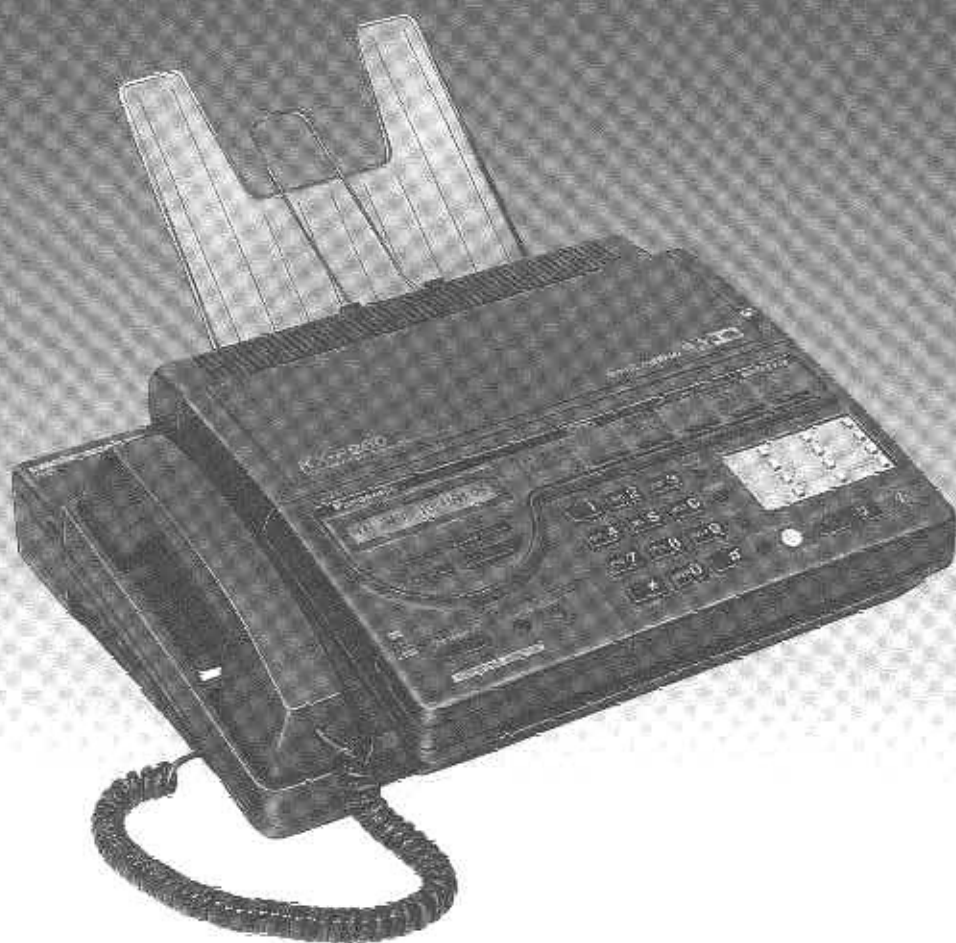

The picture shows the U.S.A. model.

Please read these Operating Instructions before using the product.

Thank you for purchasing the Panasonic Telephone Answering System with Facsimile. Before using the unit, please read these Operating Instructions completely. You can then install and operate the unit properly. This unit combines multiple functions of Facsimile, Answering Device and Telephone; You can send and receive voice-messages and documents on a single line.

Warning

To prevent fire or shock hazard, do not expose this product to rain or any type of moisture.

For the United States

Caution

The Telephone Consumer Protection Act of 1991 makes it unlawful for any person to use a computer or other electronic device to send any message via a telephone facsimile machine unless such a message clearly contains in a margin on the top or bottom of at least the first sent page the following information:

- 1) Date and time of transmission; and,
- 2) Identification of either business, business entity or individual sending the message; and,
- 3) Telephone number of either the sending machine, business, business entity or individual.

In order to program this information into your facsimile machine, you must complete the steps on pages 2-5 to 2-9 in these Operating Instructions.

Important Phone Numbers

Authorized Service Center: 1-800-545-2672
Accessory Purchases: 1-800-332-5368
Technical Support: 1-800-HELP-FAX

This serial number of the unit may be found on the label on the rear of the unit. For your convenience, note this number below, and retain this book, along with your proof of purchase, to serve as a permanent record of your purchase in the event of theft or for future reference.

MODEL NO.: _____ NAME OF DEALER: _____
SERIAL NO.: _____ DATE OF PURCHASE: _____
ADDRESS OF DEALER: _____

Any details given in these instructions are subject to change without notice.

Features

Multi-function system using one telephone line

General

- Desktop type
- LCD readout
- Automatic paper cutter
- Super thermal
- Paper Curl Reduction Technology
- Automatic voice/facsimile switching
- Silent ring fax recognition system
- Copier function
- Help function

Facsimile

- 15-second transmission speed*
- Sends/receives 216 mm (8½") × 600 mm (23⅝") pages at ITU-TS G3
- Automatic document feeder (up to 10 pages)
- One-touch sending buttons
- 16-level halftones
- Resolution: standard/fine/super fine/halftone
- Delayed transmission
- Network passcode communication
- Junk mail prohibitor
- Paper save function
- Extension copy
- Overseas transmission mode

*Transmission times apply to text data using ITU-TS No. 1 test chart, between same machine models at maximum modem speed. Transmission times vary in actual usage.

Answering Device

- Recordable greeting message chip
- Auto-Logic operation for one-touch message playback
The unit automatically plays back all recorded messages or the new messages at the touch of the ALL MESSAGES or the NEW MESSAGES button and stops at the end of the last message, then resets to answer and record the next call.
- Remote control from touch tone telephone
- Message memo recording
- New message playback

Integrated Telephone System

- Electric telephone directory
- 12-station one-touch dialer
- 100-station speed dialer
- Hands-free speakerphone with mute

Four types of receiving modes

This unit provides the following types of receiving modes. Depending on your situation, select the desired mode.

ANS/FAX (Answering device/Facsimile) mode:

When you are out of the office, and you wish to use the unit as a telephone answering device and a facsimile machine, select this mode.

The unit will automatically record a voice message and/or receive a document during your absence when a call comes in.

You should record your greeting message in the unit before using this mode.

TEL/FAX (Telephone/Facsimile) mode:

When you are in the office, and you wish to use the unit as a standard telephone and a facsimile machine, select this mode.

The unit will automatically receive a document when a fax call comes in.

You can use the unit as a standard telephone when you answer a call during ringing.

You cannot use the answering device feature provided.

FAX (Facsimile) mode:

When you wish to use the unit as a facsimile machine only, select this mode.

When a fax call comes in, the unit will automatically receive a document.

When a voice call comes in, the unit will emit a fax tone to the calling party, and you cannot talk to the other party.

Also you cannot use the answering device feature provided.

TEL (Telephone) mode:

When you wish to use the unit as a standard telephone, select this mode.

If you receive a fax call, you are able to receive a document manually. Automatic fax reception is not available.

Also you cannot use the answering device feature provided.

But the unit will be able to change to the ANS/FAX mode from the TEL mode automatically when the unit rings fifteen times.

Getting help from your unit

The unit is equipped with the HELP function. Use this function if the instructions are lost while using the unit. It will provide the user with instructions.

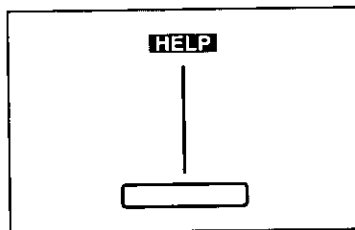

If the **HELP** button is pressed

- while programming, the unit will print the relevant programming instructions.
- in idle status, the unit will print information on how to send documents, how to set up, how to store phone numbers, etc.

Table of Contents

Chapter 1—Installation and Initial Preparation

Accessories	1-2
Precaution	1-3
Location of Controls	1-4
Front view	1-4
Rear view	1-5
Side view	1-5
Buttons and Indicators	1-6
Installing Your Unit	1-9
Installation connections	1-9
Installing the receiving tray and the diverter	1-10
Installing the microcassette tape	1-11
Installing the recording paper	1-12
Setting selectors	1-14
Turning the POWER switch on	1-15
Recording Your Greeting Message	1-16
Suggested message	1-16
Recording a greeting message	1-17
Checking your greeting message	1-17
Selecting the Receiving Mode	1-18

Chapter 2—Setting Up Your Unit

System Setup Features	2-2
How to set up	2-4
Setting date and time	2-5
Setting your logo and facsimile telephone number	2-6
How to use the character keys	2-8
Individual transmission report setting	2-10
Selecting the number of rings to answer in the ANS/FAX mode	2-12
Selecting the number of rings to answer in the FAX mode	2-14
Selecting the caller's recording time	2-15
Setting the remote code (REMOTE ANS ID) for remote operation	2-16
HELP Function —If you have lost your procedures—	2-17
Using the HELP button	2-17

Chapter 3—Basic Instructions

Facsimile and Copier

Before Transmitting Documents	3-2
Acceptable documents	3-2
Documents you cannot send	3-2
Resolution and contrast	3-3
Loading documents	3-3

Transmitting Documents	3-4
Manual transmission	3-4
Adding extra pages	3-5
Receiving Documents and/or Voice Calls	3-6
Manual reception	3-6
Automatic reception	3-7
Transmitting Documents to Your Unit	3-9
Leaving a message and transmitting documents on the same call	3-9
Transmitting documents with manual operation	3-10
Making a Copy	3-11
<i>Answering Device</i>	
Operating as an Answering Device	3-12
Setup of voice message and document reception	3-13
Listening to newly recorded messages	3-13
Listening to all the recorded messages	3-14
Recording after the messages you want to save	3-14
Monitoring incoming calls	3-15
Recording a memo message	3-15
Recording a telephone conversation (2-way recording)	3-16
<i>Telephone</i>	
Making and Answering Voice Calls	3-17
Making voice calls	3-17
Redialing the last dialed number	3-18
Answering voice calls	3-18

Chapter 4—Intermediate Instructions

Storing Phone Numbers for Automatic Dialing	4-2
Filling in the directory card	4-2
Storing phone numbers for one touch dialing	4-3
Storing phone numbers for speed dialing	4-5
Storing secret phone numbers	4-7
Electric Telephone Directory	4-9
How to use the Electric Telephone Directory	4-10
<i>Facsimile</i>	
Transmitting Documents Using Automatic Dialer	4-11
Transmitting Documents Using Electric Telephone Directory	4-12
<i>Telephone</i>	
Making Voice Calls Using Automatic Dialer	4-13
Making Voice Calls Using Electric Telephone Directory	4-14

Chapter 5—Advanced Instructions

Facsimile and Copier

Delayed Transmission	5-2
Network Communication	5-4
Using a passcode	5-4
Programming the network passcode	5-6
Turning the TX passcode check on	5-7
Turning the RX passcode check on	5-8
Junk Mail Prohibitor	5-9
Turning on the junk mail prohibitor	5-9
Transmitting documents to your unit with a special code	5-11
Remote Fax Receiving Using an Extension Phone	5-12
Using an extension phone	5-12
Changing a remote fax activation code	5-13
Receiving with Distinctive Ring Service	5-14
Programming the unit with distinctive ringing pattern	5-15
Using the OVERSEAS/TRANSMIT SETTING Button	5-16
Using overseas transmission mode	5-16
Setting a total page number on your fax document	5-16
Setting the Logo Print Position	5-18
Setting the Paper Save Function	5-19
Extension Copy	5-21
<i>Answering Device</i>	
Operating the Answering Device from a Remote Phone	5-23
Summary of remote control functions	5-23
Playing back newly recorded messages (Memory playback)	5-24
Playing back all messages	5-24
Back space and skip forward	5-25
Recording a marker message	5-25
Resetting the tape for future messages	5-26
Answer back	5-27
Skipping the greeting message for incoming message recording mode	5-27
Re-recording a greeting message	5-28
Setting the Message Alert	5-29
<i>Telephone</i>	
Voice Contact	5-30
Initiating voice contact	5-30
Receiving a request for voice contact	5-30
TONE, FLASH and PAUSE Button Usage	5-31
TONE button (Temporary tone dialing)	5-31
FLASH button	5-31
PAUSE button	5-32
Combination dialing	5-32

<i>Other Features</i>	
Setting Day/Night Mode	5-33
Setting Silent Fax Recognition Ring	5-35
Resetting the Setup Features	5-36

Chapter 6—Printing Reports and Lists

Activity Report (JOURNAL Report)	6-2
Setting the JOURNAL AUTO PRINT	6-3
Printing a JOURNAL report manually	6-4
List of Stored Phone Numbers (TELEPHONE NUMBER LIST)	6-5
Printing a TELEPHONE NUMBER LIST	6-6
Basic Feature List	6-7
Advanced Feature List	6-8

Chapter 7—Troubleshooting and Maintenance

Troubleshooting	7-2
Error messages	7-2
General corrective measures	7-3
Clearing a document jam	7-6
Clearing a recording paper jam	7-7
Maintenance	7-9
Cleaning the microcassette compartment	7-9
Cleaning the document feeder unit	7-10
Cleaning the thermal head	7-10
Printing a test pattern	7-11

Chapter 8—General Information

Accessory Order Information	8-2
Specifications	8-3
For Users in the United States	8-4
For Users in Canada	8-6
Index	8-8

Chapter 1

Installation and Initial Preparation

Table of contents

Accessories	1-2
Precaution	1-3
Location of Controls	1-4
Front view	1-4
Rear view	1-5
Side view	1-5
Buttons and Indicators	1-6
Installing Your Unit	1-9
Installation connections	1-9
Installing the receiving tray and the diverter	1-10
Installing the microcassette tape	1-11
Installing the recording paper	1-12
Setting selectors	1-14
Turning the POWER switch on	1-15
Recording Your Greeting Message	1-16
Suggested message	1-16
Recording a greeting message	1-17
Checking your greeting message	1-17
Selecting the Receiving Mode	1-18

When the display shows any error message, see page 7-2 for corrective measures.

Accessories

1. Carefully remove the unit from the packing carton.
2. Examine the unit for signs of shipping damage.
3. Check that all of the enclosures are included. If you are missing any item, consult your place of purchase.

Telephone Line Cord 1

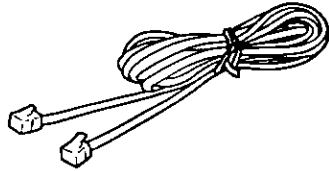

AC Power Cord 1

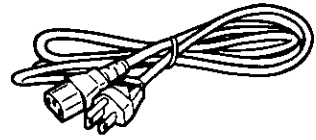

Microcassette Tape 1

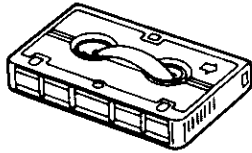

Recording Paper 1
(Super Thermal Paper)

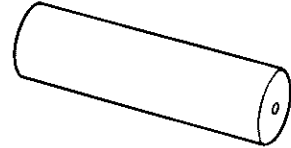

Handset 1

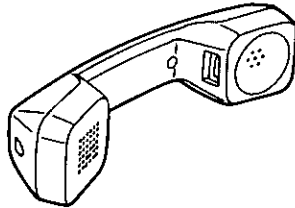

Handset Cord 1

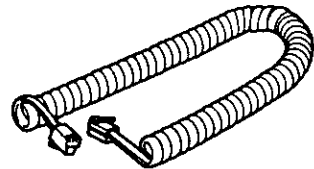

Paper Roll Holders (Green) 2
(For the recording paper with 1/2 inch core)

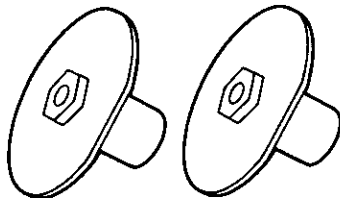

Receiving Tray 1

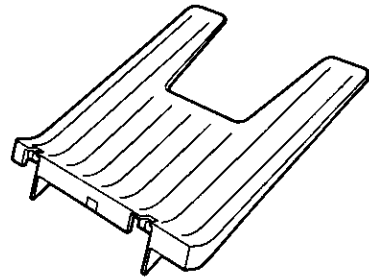

Diverter 1

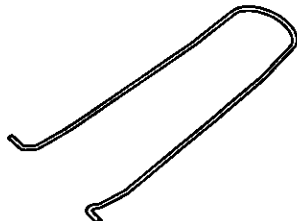

Precaution

Keep the unit away from heating appliances such as radiators or air conditioning units.

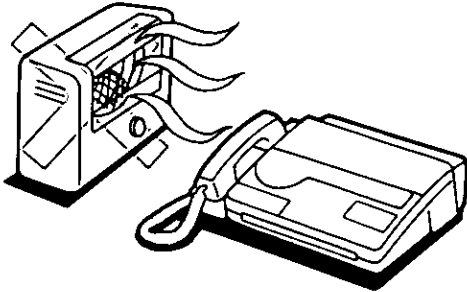

Keep the unit away from electrical noise generating devices such as fluorescent lamps and motors.

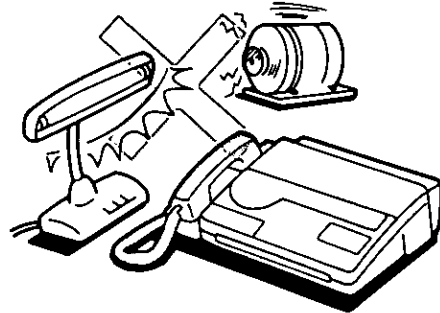

The unit and the cassette tape should not be exposed to direct sunlight.

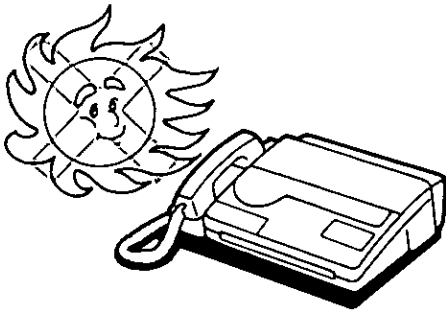

The unit and the cassette tape should be kept free from dust, moisture, high temperature and vibration.

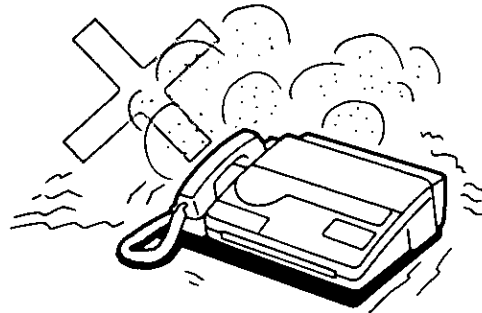

Do not use benzine, thinner, or the like, or any abrasive powder to clean the cabinet. Wipe it with a soft cloth.

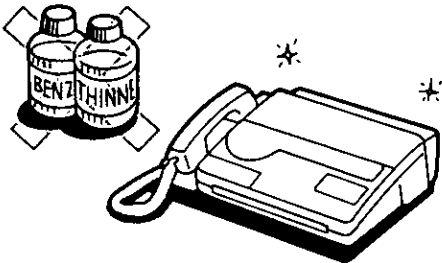

Do not place any covering over the unit while it is turned on.

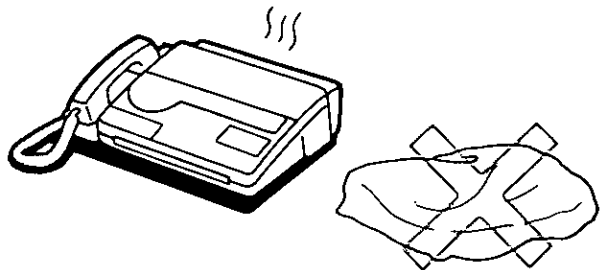

Location of Controls

Front view

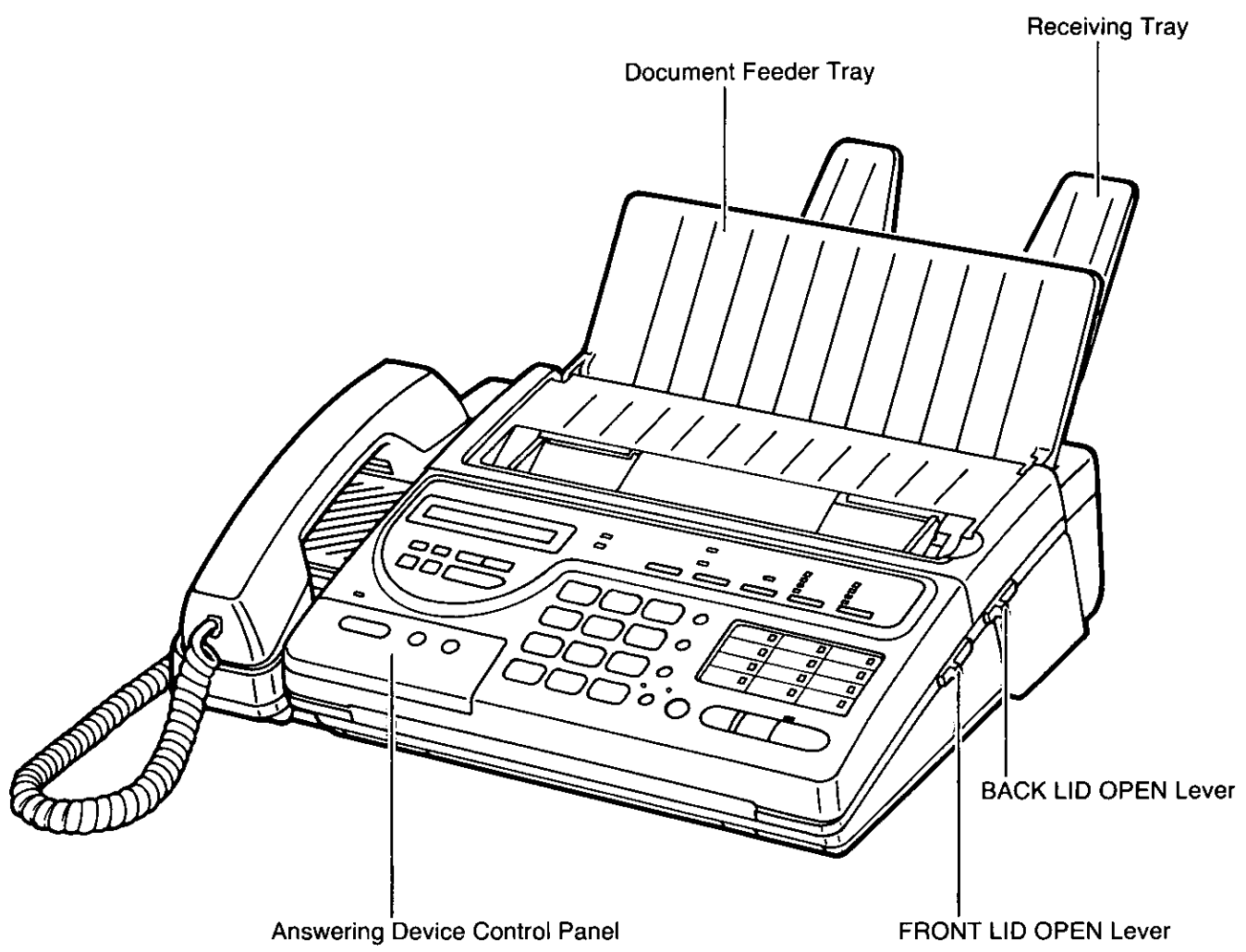

Rear view

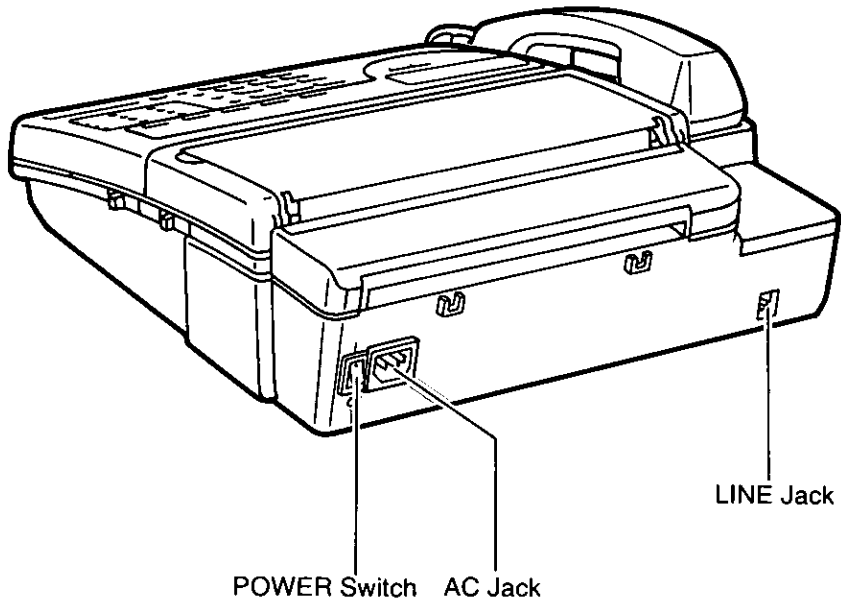

Side view

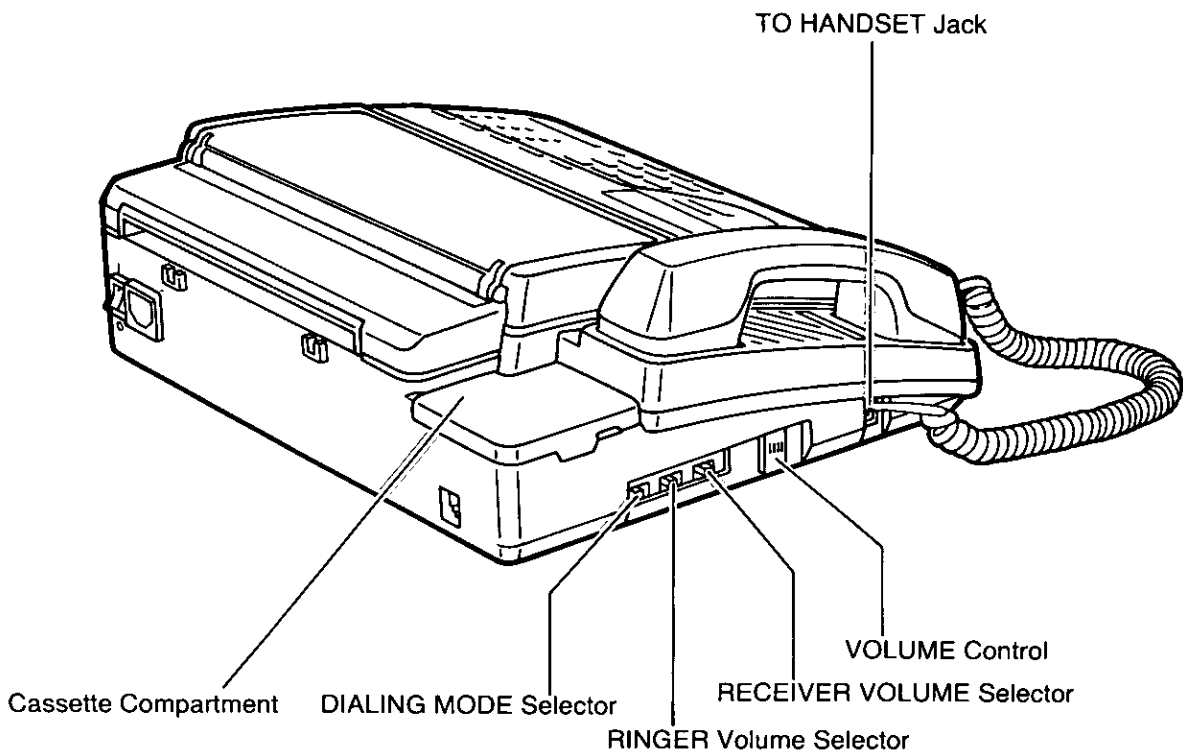

Buttons and Indicators

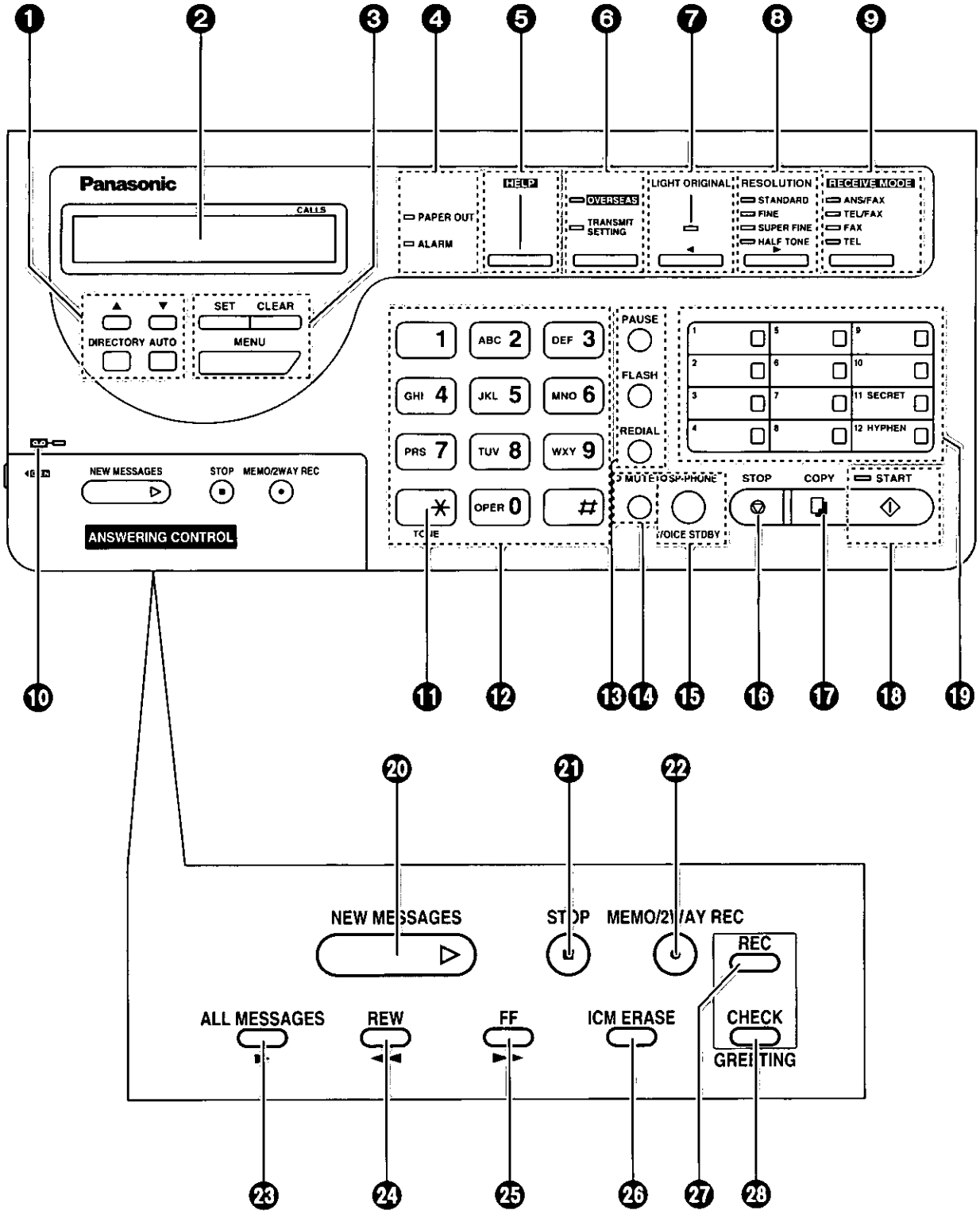

- 1 ▲ Button:**
Page 4-10

Used to put back the items in the electric telephone directory.
- ▼ Button:**
Page 4-10

Used to advance the items in the electric telephone directory.
- DIRECTORY Button:**
Page 4-10

Used to enter the electric telephone directory mode.
- AUTO Button:**
Pages 4-5, 4-7, 4-11 and 4-13

Used for speed dialing.
- 2 LCD (Liquid Crystal Display)**
- 3 SET Button:**
Page 2-4

Used to store parameters during programming.
- CLEAR Button:**
Page 2-4

Used to clear the previously entered parameters during programming.
- MENU Button:**
Pages 2-4 and 5-2

Used to start delayed transmission, system setup, etc.
- 4 PAPER OUT Indicator:**
Pages 1-13 and 1-15

The indicator lights when the recording paper roll is empty.
- ALARM Indicator:**
Page 1-15

The indicator lights when any trouble occurs.
- 5 HELP Button:**
Page 2-17

Used to print an easy guide of programming procedures.
- 6 OVERSEAS/TRANSMIT SETTING Button and Indicators:**
Pages 5-16 and 5-17

Used for overseas facsimile transmission. Also used to set the total page number before transmission. The indicators light when these features are on.
- 7 LIGHT ORIGINAL Button and Indicator/◀ Key:**
Pages 2-9 and 3-3

Used to transmit or copy originals with faint writing. The indicator lights when this feature is on. Also used as the cursor key during programming.
- 8 RESOLUTION Button and Indicators/▶ Key:**
Pages 2-9 and 3-3

Used to adjust scanning line density. The indicators light to show which setting you are using. Also used as the cursor key during programming.
- 9 RECEIVE MODE Button and Indicators:**
Pages 1-18 and 3-7

Used to select the desired receiving mode. The indicators light to show the mode in which the unit is set.
- 10  Indicator:**
Page 3-12

The indicator flashes when any new incoming messages have been recorded.
- 11 TONE Button:**
Page 5-31

Used to change the dialing mode from pulse to tone during a dialing operation.
- 12 Dial Keypad/Character Keys:**
Pages 2-8 and 2-9

Used to dial phone numbers or enter parameters while programming. Also used as character keys when logo and station names are programmed.

- 13 PAUSE Button:**
Page 5-32
Used to insert a pause into a phone number during a dialing operation or programming.
- FLASH Button:**
Page 5-31
Used to access some features of your host PBX.
- REDIAL Button:**
Page 3-18
Used to redial the last dialed number.
- 14 MUTE Button and Indicator:**
Used when you do not want your voice to be heard by the other party. The voice of the calling party will still be heard. The indicator lights when this feature is on.
- 15 SP-PHONE (VOICE STDBY) Button and Indicator:**
Pages 3-4, 3-6, 3-17 and 5-30
Used for on-hook dialing and voice contact features. The indicator lights when these functions are on.
- 16 STOP (⊙) Button:**
Pages 3-4, 3-5 and 3-11
Used to cancel transmission or copying operation.
- 17 COPY Button:**
Page 3-11
Used to start copy functions.
- 18 START Button and Indicator:**
Pages 3-4 to 3-6
Used to start transmission or print lists and reports. The indicator lights when these functions are on.
- 19 Direct Call Station Keys/
Character Keys:**
Pages 2-8, 4-2, 4-3, 4-11
and 4-13
Used for one touch dialing.
Also used as character keys when logo and station names are programmed.
- 20 NEW MESSAGES Button:**
Page 3-13
Used to play back only new messages.
- 21 STOP (■) Button:**
Page 3-12
Used to stop operations of answering device.
- 22 MEMO/2WAY REC Button:**
Pages 3-15 and 3-16
Used to start and stop recording of a memo message or a telephone conversation.
- 23 ALL MESSAGES Button:**
Page 3-14
Used to play back all the recorded messages.
- 24 REW (Rewind) Button:**
Pages 3-12 and 3-13
Used to run the tape quickly backward to a desired point.
- 25 FF (Fast Forward) Button:**
Page 3-12
Used to run the tape quickly forward to a desired point.
- 26 ICM ERASE Button:**
Page 3-12
Used to erase recorded incoming messages at high speed.
- 27 REC Button:**
Page 1-17
Used to start and stop recording of a greeting message.
- 28 CHECK Button:**
Page 1-17
Used to replay your greeting message.

Installing Your Unit

Installation connections

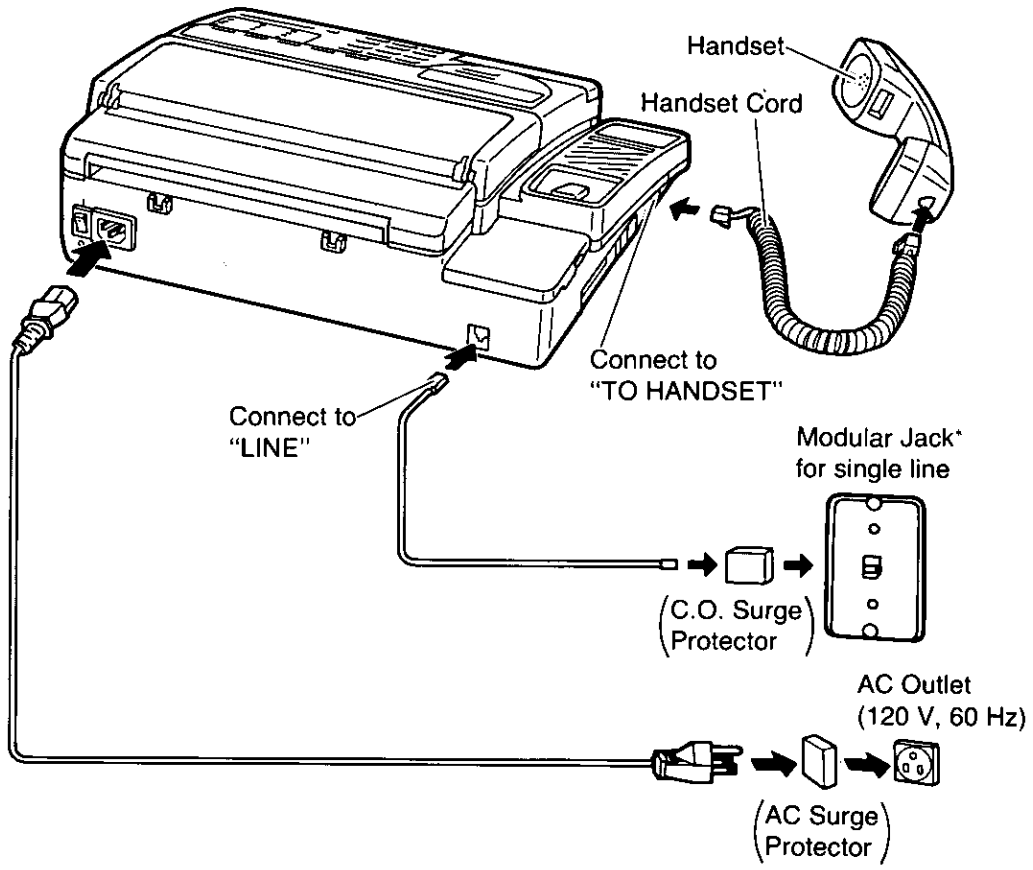

NOTES:

- The unit will not function during a power failure or when the power is turned off.
- Connection to integrated answering machines is not recommended.
- This unit is equipped with a 3-wire grounded type plug for safety. If you are unable to insert the plug into your outlet, contact your electrician to replace your outlet.
- We recommend the use of an exclusive AC outlet to avoid interference from other equipment.
- Place the equipment close to the socket outlet so the socket is easily accessible.
- If your unit is connected to the same line as other extensions, do not use other extensions during fax transmission and reception. Image quality will be affected.
- In areas of frequent electrical storms and/or power failure, we recommend using additional equipment protection (surge protector). For further details, consult with your service centers.

*USA...RJ11C
CANADA...CA11A

Installing the receiving tray and the diverter

To install the receiving tray:

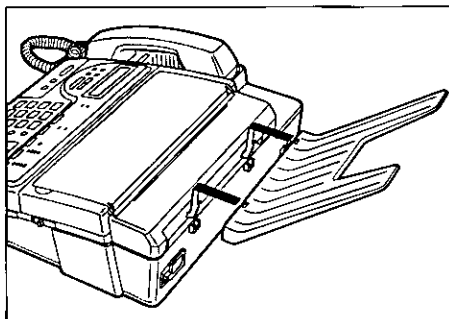

Insert two fins of the tray into holders on the rear side of the unit.

To install the diverter:

The diverter will hold the received documents straight and flat.

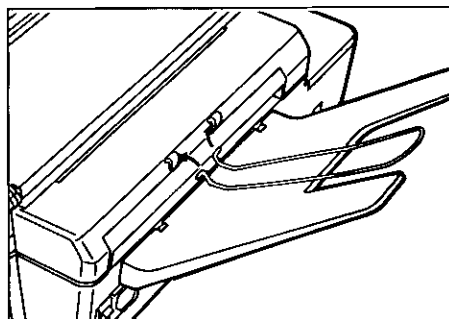

Insert two hooks of the diverter into holders on the rear side of the unit.

Make sure that the diverter is placed in proper direction.

Installing the microcassette tape

The microcassette tape is used to record incoming messages.
To install a microcassette tape, proceed as follows:

1

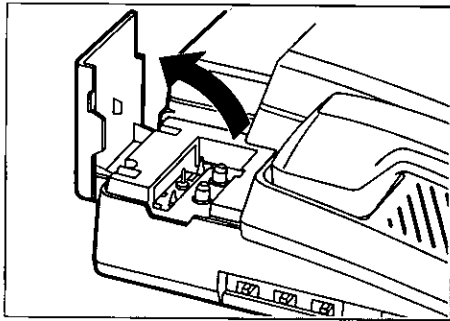

Pull up the cassette compartment cover.

2

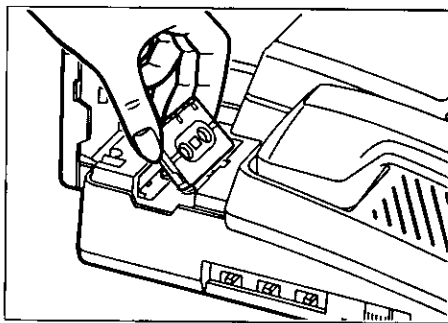

Insert the microcassette tape into the compartment with the full reel to the left. Make sure that there is no slack in the tape. Remove any slack by using a pencil and rotating the tape reel.

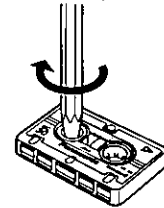

3

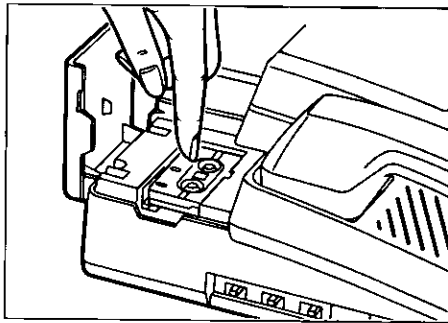

Push the microcassette tape down. Then close the cassette compartment cover.

To take off the microcassette tape:

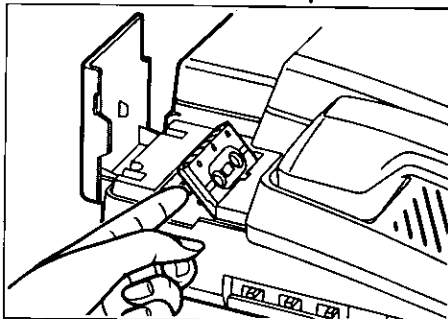

Lift the microcassette tape as shown, then take it off.

NOTES:

- For optimum sound quality and performance, use the opposite side (side B) after six months and replace the tape with a new one every year, assuming that the unit answers about ten calls a day.
- Never place a cassette tape near a magnetic source such as a magnet or a TV set. It may erase or interfere with any messages on the tape.
- Should the cassette tape break or become worn, replace it with a new one. We recommend using the Panasonic cassette tape **MC-30** or **MC-60**.

Installing the recording paper

To install a new roll of recording paper, proceed as follows:

1

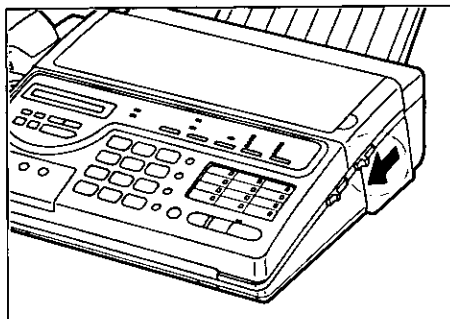

Slide the **BACK LID OPEN** lever forward to open the paper compartment cover.

2

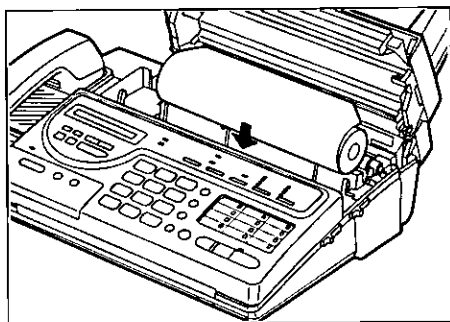

Place a recording paper roll into the paper compartment.

Make sure that the shiny side of the paper is facing up and that there is no slack in the paper roll.

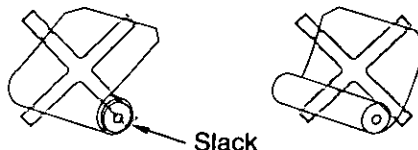

3

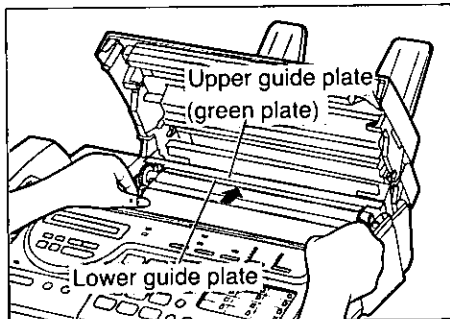

Insert the leading edge of recording paper between the upper guide plate (green plate) and the lower guide plate.

4

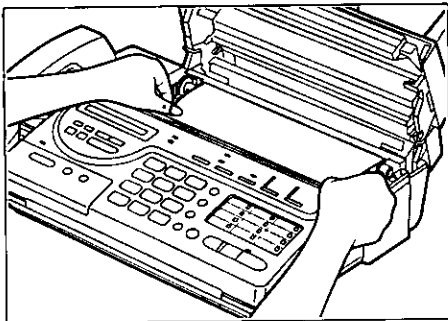

Pull the paper a few centimeters (one or two inches) out of the unit.

5

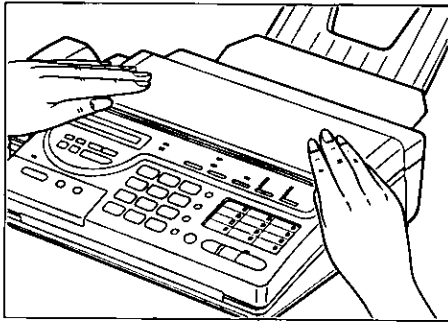

Close the paper compartment cover carefully by pressing down on both ends gently.

When the unit is on, the recording paper will project itself slightly and be cut automatically.

NOTES:

- Use only the included roll or high quality recording paper recommended by Panasonic or else the print quality may be affected or excessive thermal head wear may occur.
- To install a recording paper roll with 1/2 inch core, you should use the included paper roll holders for paper curl reduction system as shown below.

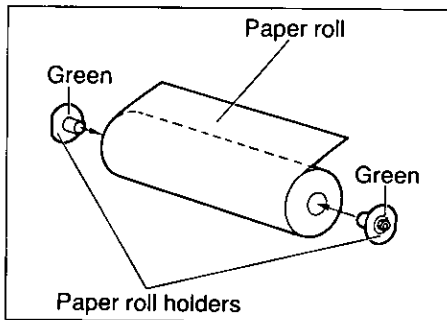

Fix the paper roll holders on both sides of the recording paper roll.

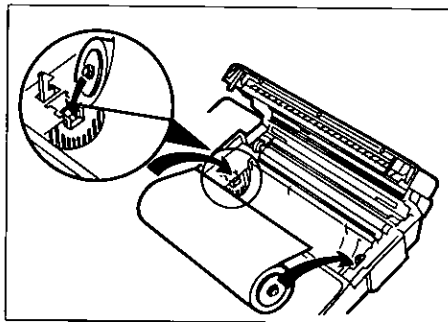

Insert the left projection of the paper roll holder into the left groove on the unit then the right projection into the right groove, while pushing the paper roll to the left.

Follow the procedures from steps 3 to 5 to finish installing a recording paper roll with 1/2 inch core.

- If the recording paper is heavily curled, the paper curl reduction system may not function properly.
- Replace the paper roll with a new one;
 - when the red lines appear on both sides of the recording paper.
 - when the PAPER OUT indicator lights.
 - when the display shows "OUT OF PAPER".

Setting selectors

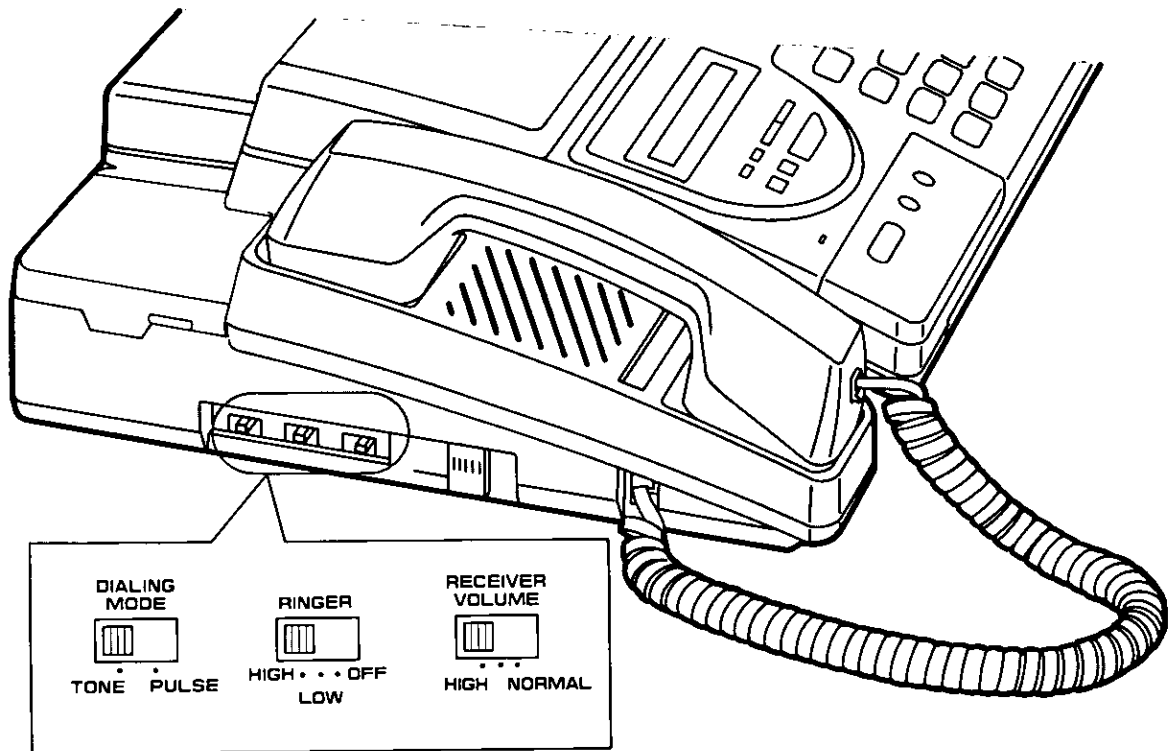

DIALING MODE Selector:

If your line has,

1. Touch tone service, set the selector to **TONE**.
2. Rotary pulse dial service, set the selector to **PULSE**.

RINGER Volume Selector:

HIGH: The ringing sound will be loud.

LOW: The ringing sound will be soft.

OFF: The unit will not ring.

RECEIVER VOLUME Selector:

Adjust the volume level of the handset receiver using the **RECEIVER VOLUME** selector.

The **RECEIVER VOLUME** selector can be moved to 3 positions. The center between **HIGH** and **NORMAL** is the middle level of volume.

When the other party's voice is hard to hear, move the switch to the center or **HIGH**.

Turning the POWER switch on

Before turning the POWER switch on, confirm the following:

- All connections are completed.
- The cassette tape and the recording paper are installed properly.
- The handset is on the cradle.

1. Turn the **POWER** switch to the "I" (ON) position.

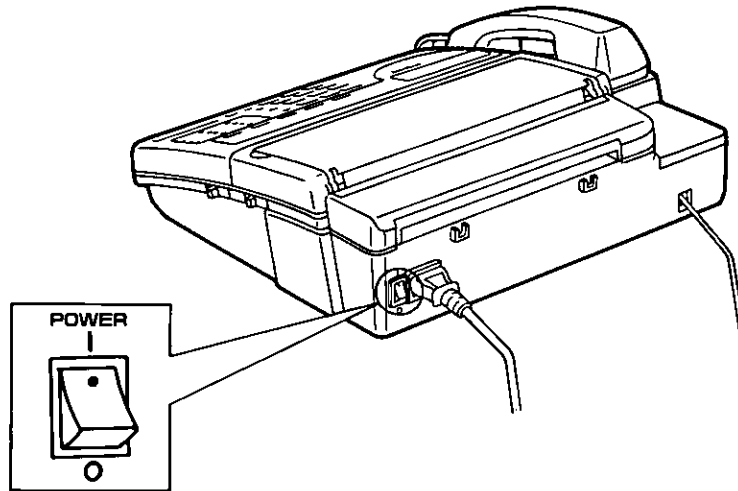

2. When you turn on the unit for the first time, the display shows "**RECORD GREETING**". This shows that the greeting message is not recorded.
To use the unit as both an answering device and a facsimile properly, record your greeting message (see pages 1-16 and 1-17).

NOTES:

- If the **ALARM** indicator lights when you turn the **POWER** switch on, confirm that the cover of the recording paper unit is closed firmly.
- If the **PAPER OUT** indicator lights, install the recording paper properly (see pages 1-12 and 1-13).

Recording Your Greeting Message

Record a greeting message before using your machine as an answering machine and facsimile.

The greeting message tells the caller that you are unable to answer, and allows him or her to leave a voice-message or to send a fax message.

You can store a greeting message up to 16 seconds.

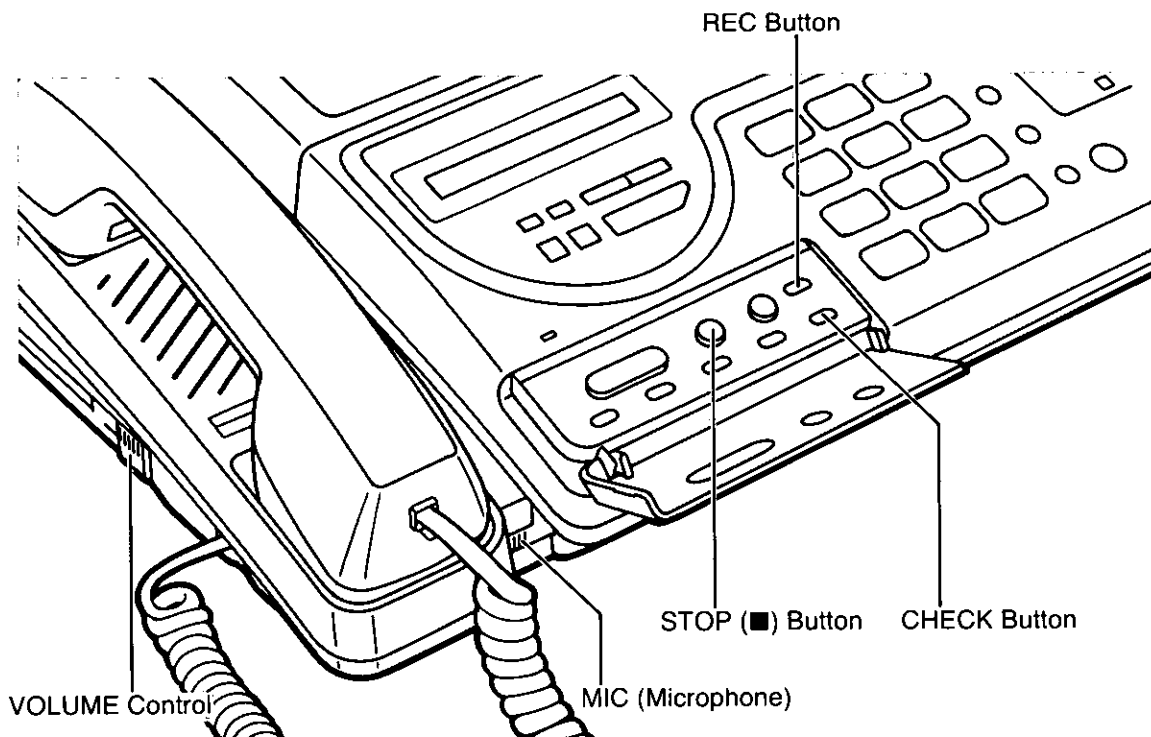

Suggested message

Record your greeting message referring to the examples below.

—When the incoming message recording time is unlimited:

"This is (your name, business and/or telephone number). We are unable to answer right now. To send a fax, start transmission. To leave a message, speak after the long beep. Thank you."

—When the incoming message recording time is limited to 1 minute:

*"This is (your name, business and/or telephone number). We are unable to answer right now. To send a fax, start transmission. To leave a message, speak for **up to 1 minute** after the long beep. Thank you."*

You can choose from two lengths of recording times for incoming messages. When the unit is in the "VOX" position, the recording time is unlimited, and when in the "1MIN" position, the recording time is limited to 1 minute. The two examples above correspond to these two conditions. The unit is preset to the "VOX" position. To change the recording time, see page 2-15.

Recording a greeting message

Recording time is limited to 16 seconds. Record your greeting message within 12 seconds for optimum performance.

1

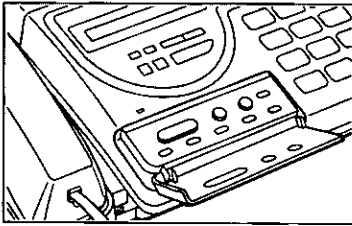

Open the **ANSWERING CONTROL** panel.

2

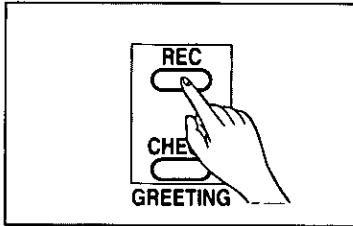

Press the **REC** button.

A beep is heard.



3

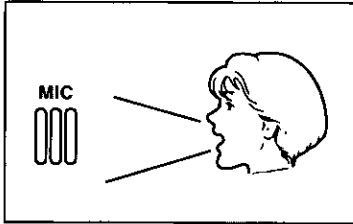

After the beep, speak immediately, clearly and loudly toward the microphone from a distance of approximately 20 cm (8 inches).



4

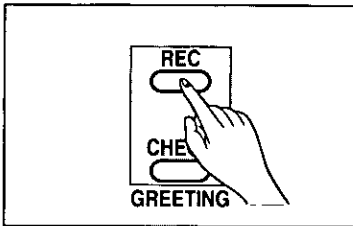

When finished, press the **REC** button again or the **STOP (■)** button.

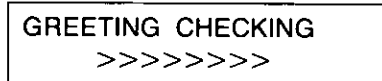

5

The unit plays back your greeting message so that you can confirm it.

Adjust the **VOLUME** control to a suitable level.



NOTE:

If you make a mistake while recording, repeat from step 1.

Checking your greeting message

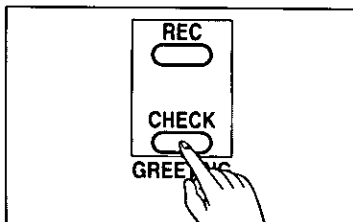

Press the **CHECK** button.

The unit replays your greeting message. If you want to change your message, perform the operation on this page again. The previous message will be automatically erased and a new message will be recorded.

Selecting the Receiving Mode

Depending on your situation, select the desired receiving mode referring to the explanations below.

- ANS/FAX mode** —When you wish to use the unit as a telephone answering device and a facsimile machine.
- TEL/FAX mode** —When you wish to use the unit as a standard telephone and a facsimile machine.
- FAX mode** —When you wish to use the unit as a facsimile machine only.
- TEL mode** —When you wish to use the unit as a standard telephone.

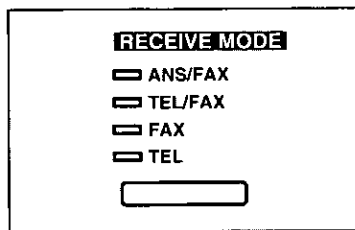

Press the **RECEIVE MODE** button to select the desired receiving mode.

When a fax or voice call comes in, the unit will function as follows.

ANS/FAX mode

- When a voice call comes in, the unit will ring and play your greeting message recorded to the calling party, and the unit will be ready to record a voice of the other party.
- If the calling party does not wish to record any voice message, advise them to press their asterisk (*) key using tone dialing while playing the greeting message or incoming message recording mode. The answering device feature will be interrupted and the unit will activate the fax function. The calling party will be able to send a document.
- If the calling party wishes to send document after hearing your greeting message, advise them to leave their handset with mute for 5 seconds more. The unit will activate the fax function, and the calling party will be able to send a document.
- When a fax call comes in, the unit will ring and activate the fax function without playing your greeting message.

NOTES:

- You should record your greeting message first into your unit before using this mode. See page 1-16.
- You can program the recording time for a voice of the other party. See page 2-15.
- When a call comes in, the unit will ring depending on the setting of the ANS/FAX ring count. You can also set the ringer to off. To change the setting, see page 2-12.
- If you answer the call during playing the greeting message or recording an incoming voice message, you will be able to talk to the other party.
- When you answer a call and the pip tones sound or nothing is heard, the call may be a fax call. Press the START button to receive a document.

TEL/FAX mode

- When a call comes in, the unit will seize the call immediately and distinguish between a voice and a fax call.
- When a voice call is received, the unit will ring 3 to 8 times depending on the setting of the silent fax recognition ring (see page 5-35). You will pick up the handset or press the SP-PHONE button to talk to the other party. While ringing, the unit will emit different ring back tone to the calling party.
If anyone does not answer the call, the unit will automatically activate the fax function. The calling party will be able to send a document.
- When a fax call is received, the unit will automatically activate the fax function without ringing.

NOTE:

- Telephone fee will be charged to the calling party once the different ring back tone is heard, because the line is already connected from that time.
- When you answer a call and pip tone is heard or nothing is heard, the call may be a fax call. Press the START button to receive a document.
- When a call comes in, an extension phone, if connected on the same line, will ring 1 to 4 times depending on the setting of the FAX RING COUNT (see page 2-14) before the unit rings or initiates fax reception.
- The unit can distinguish between a voice and fax call by detecting the calling tone (CNG), sent by the transmitting fax machines.
Some fax messages that are transmitted manually may be received after the unit rings, because some fax machines do not send calling tone in manual mode.

FAX mode

- When a fax call comes in, the unit will ring and activate the fax function.
- When a voice call comes in, the unit will ring and emit a fax tone to the calling party. The calling party will be able to send a document. You cannot talk to the other party.

NOTE:

- When a call comes in, the unit will ring depending on the setting of the FAX ring count. To change the setting, see page 2-14.
- When you answer a call and pip tone sounds or nothing is heard, the call may be a fax call. Press the START button to receive a document.
- Inform your callers that your unit is used for a facsimile machine only.

TEL mode

- When a call comes in, you will have to answer every call.
- When you answer a call and pip tone is heard or nothing is heard, the call may be a fax call. Press the START button to receive a document.

NOTE:

- If anyone does not answer the call by 15 rings, the receiving mode of the unit will be changed to the ANS/FAX mode automatically.

Chapter 2

Setting Up Your Unit

Table of contents

System Setup Features	2-2
How to set up	2-4
Setting date and time	2-5
Setting your logo and facsimile telephone number	2-6
How to use the character keys	2-8
Individual transmission report setting	2-10
Selecting the number of rings to answer in the ANS/FAX mode	2-12
Selecting the number of rings to answer in the FAX mode	2-14
Selecting the caller's recording time	2-15
Setting the remote code (REMOTE ANS ID) for remote operation	2-16
HELP Function	
—If you have lost your procedures—	2-17
Using the HELP button	2-17

When the display shows any error message, see page 7-2 for corrective measures.

System Setup Features

The unit has 9 Basic Features listed below, and 15 Advanced Features, as listed on page 2-3.

Basic Features are the settings that need to be programmed upon finishing the installation. Most probable choices have been preselected for you, but some features, such as **SET DATE, YOUR LOGO** and **YOUR TELEPHONE NUMBER**, must be programmed by the user.

Advanced Features should be temporarily programmed as the need arises.

BASIC FEATURE LIST

The bold-face indicates factory default settings.

Code	Functions	Descriptions	Selections	Pages
#01	SET DATE	Sets the current date and time	(not stored)	2-5
#02	YOUR LOGO	Sets your company name or personal name	up to 30 digits	2-6 2-7
#03	YOUR TELEPHONE NUMBER	Sets your facsimile telephone number	up to 20 digits	2-6 2-7
#04	PRINT TRANSMISSION REPORT	Individual transmission report setting	ERROR/ON/OFF	2-10 2-11
#05	ANS/FAX RING COUNT	Selects the number of rings to answer in the ANS/FAX mode, or sets RINGER to off	TOLL SAVER or 1 to 4 rings or RINGER OFF	2-12 2-13
#06	FAX RING COUNT	Selects the number of rings to answer in the FAX mode	1 to 4 rings	2-14
#07	RECORDING TIME FOR ANS	Selects the recording time for incoming message	VOX (unlimited) or 1MIN (1 minute)	2-15
#08	REMOTE ANS ID	Sets the remote control code for remote operation	3 digits (111)	2-16
#99	PRINT ADVANCED FEATURE LIST	Prints the advanced feature list		6-8

ADVANCED FEATURE LIST

The bold-face indicates factory default settings.

Code	Functions	Descriptions	Selections	Pages
#10	LOGO POSITION	Sets the LOGO print position on the transmitted document	OUT/IN/OFF	5-18
#11	JOURNAL AUTO PRINT	Prints out the journal report automatically or manually	AUTO/MANUAL	6-3
#12	NETWORK PASSCODE	Sets the passcode for network communication	4 digits (0000)	5-6
#13	TX PASSCODE CHECK	Turns the transmission passcode check mode on	ON/OFF	5-7
#14	RX PASSCODE CHECK	Turns the reception passcode check mode on	ON/OFF	5-8
#18	DAY/NIGHT MODE	Turns on the Day/Night Mode	ON/OFF	5-33 5-34
#19	SILENT FAX RECOGNITION RING	Sets the silent fax recognition ring	3 to 8 rings	5-35
#20	REMOTE FAX ACTIVATION CODE	Sets the remote fax activation code	2 to 4 digits (**)	5-13
#21	PAPER SAVE FUNCTION	Turns on the paper save function	ON/OFF	5-19 5-20
#22	MESSAGE ALERT	Turns on the message alert	ON/OFF	5-29
#23	RING PATTERN DETECTION	Sets the distinctive ring pattern that will be detected	A/B/C/D/OFF	5-15
#24	EXTENSION COPY	Copies a document twice in length		5-21 5-22
#28	PRINTER TEST	Prints a print test pattern		7-11
#38	JUNK MAIL PROHIBITOR	Turns on the junk mail prohibitor function. Also sets a special code.	ON/OFF JUNK MAIL PROHIBITOR ID =2 digits (22)	5-9 5-10
#50	SET DEFAULT (#10 TO #38)	Resets the setup features	YES/NO	5-36

How to set up

To set up your unit, proceed as follows:

1. Press the **MENU** button until the following is shown.

The display shows;

```
PROGRAM[1.DATE 2.TEL
3.SYSTEM 4.REPORT]
```

2. Press 1 for setting date and time.

```
SET DATE [*=AM #=PM]
01 01 94 12:00AM SAT
```

or

Press 2 for storing phone numbers.

```
SELECT AUTO OR
DIRECT CALL KEY
```

or

Press 3 for programming system setup features.

```
ENTER YOUR LOGO
=
```

The display shows the next feature each time you press the **SET** button.

If you press the **CLEAR** button, the display shows the previous setup feature.

You can select the desired feature directly by pressing # and code number (see pages 2-2 and 2-3).

or

Press 4 for printing reports and lists.

```
SELECT NO.[1.SYSTEM
2.TEL NO. 3.JOURNAL]
```

3. Referring to the page listed on pages 2-2 and 2-3, enter your selection or data, then press the **SET** button if necessary.
4. Press the **MENU** button to end the operation.

NOTES:

- When you lose your procedures while programming, press the **HELP** button. You will be able to print information about how to set up (see pages 2-17 and 2-18).
- To correct an error while programming, press the **CLEAR** button then correct input.
- To cancel programming on the way, press the **MENU** button. The display shows the current time.

Setting date and time

The internal clock of the unit will print the date and time on the top line of all fax messages you transmit and the fax communication reports such as JOURNAL report and TX (transmission) REPORT.

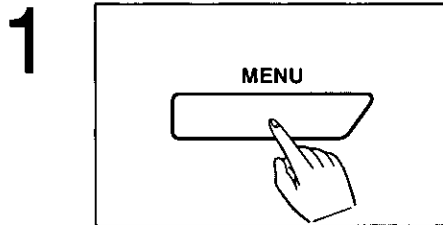

Press the **MENU** button until the following is shown.

```
PROGRAM[1.DATE 2.TEL  
3.SYSTEM 4.REPORT]
```

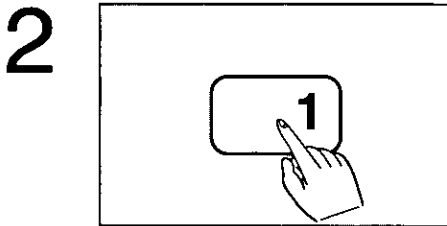

Press 1 for SET DATE setting.

```
SET DATE [*=AM #=PM]  
01 01 94 12:00AM SAT
```

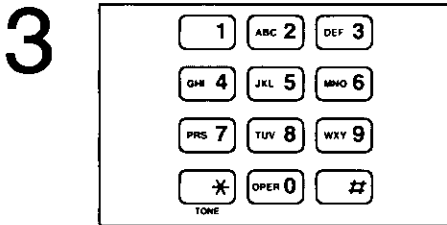

Enter current month/day/year/hour/minute by selecting 2 digits each using the dial keypad.

Example: Aug. 10 1994, 3:00PM.
Press **08, 10, 94, 03**, then press **00**.
Press # to select PM mode.

```
SET DATE [*=AM #=PM]  
08 10 94 03:00PM WED
```

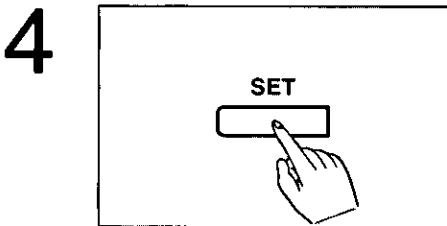

Press the **SET** button to store the program in memory.

```
PROGRAM[1.DATE 2.TEL  
3.SYSTEM 4.REPORT]
```

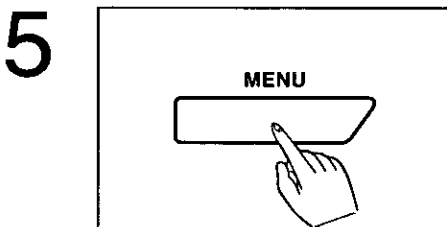

Press the **MENU** button to end the operation.

```
WED AUG 10 3:00PM --
```

NOTE:

If you make a mistake in step 3, use the cursor key (◀ or ▶) to move the cursor to the incorrect number, then make the correction.

Setting your logo and facsimile telephone number

YOUR LOGO: The logo is used to identify fax documents sent by your unit. It may consist of alphanumeric letters and symbols. Usually the logo is a company, division or personal name in an abbreviated form. Your printed logo can be up to 30 digits long.

YOUR FACSIMILE TELEPHONE NUMBER: Your facsimile telephone number can be programmed into your unit. The unit can hold your phone number up to 20 digits long.

Your programmed logo and telephone number will be printed on the top of each page transmitted from your unit, along with date, time and page number.

This gives the receiving party your name and fax telephone number if they wish to return a fax.

Sample page sent by your unit

YOUR LOGO YOUR FACSIMILE TELEPHONE NUMBER Date and time Page number

FROM : ABC Company PHONE NO. : +123 4567 Jan. 01 1994 03:05AM P 1

FAX CORRESPONDENCE

TO: _____ DATE: _____

FROM: _____ OUR TEL. NO.: _____

To set your logo and facsimile telephone number, proceed as follows:

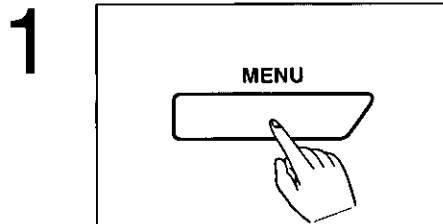

Press the **MENU** button until the following is shown.

PROGRAM[1.DATE 2.TEL
3.SYSTEM 4.REPORT]

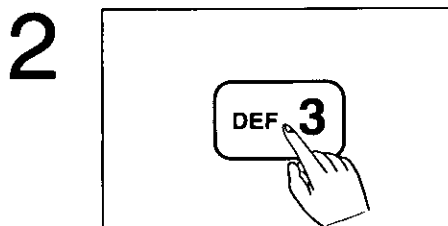

Press **3**.

ENTER YOUR LOGO
=

3

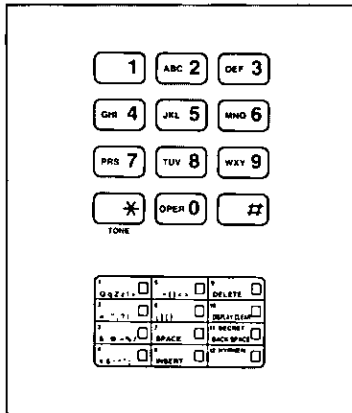

Enter your logo by using the character keys and the cursor keys.

Example: The logo is ABC.

Press 2 once to select "A" then ► key, press 2 three times to select "B" then ► key and press 2 five times to select "C".

ENTER YOUR LOGO
=ABC

4

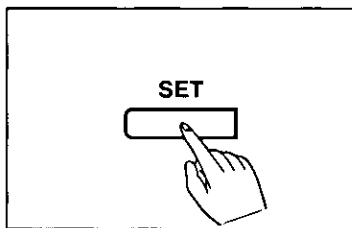

When finished, press the **SET** button to store the program in memory.

ENTER YOUR TEL NO.
=

5

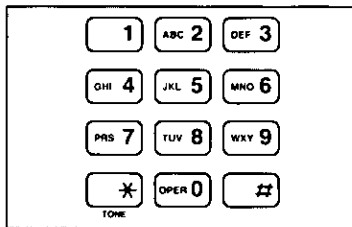

Enter your facsimile telephone number.

Example: If the phone number is +123 4567, press *, 123, #, then press 4567.

ENTER YOUR TEL NO.
=+123 4567

The * button provides "+" and the # button provides a space.

6

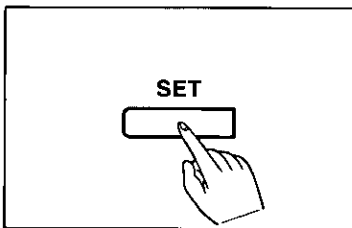

Press the **SET** button to store the program in memory.

XMT REPORT=ERROR
[1.ERROR 2.ON 3.OFF]

7

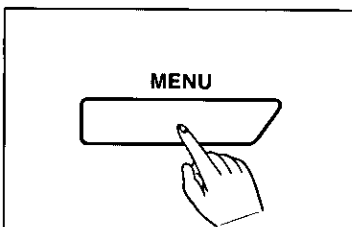

Press the **MENU** button to end the operation.

The display shows the current time.

NOTES:

- To enter the logo, use the character keys and the cursor keys (◀ or ▶). For further details, see pages 2-8 and 2-9.
- If you make a mistake in step 3, use the cursor key (◀ or ▶) to move the cursor to the incorrect number, then make the correction.
- If you make a mistake in step 5, press the **CLEAR** button then make the correction.

How to use the character keys

The dial keypad and the direct call station keys are also used as alphabet and symbol character input keys when you program your logo and other station names.

Each alphabet and symbol character is assigned to keys as follows:

Dial Keypad

Keypad	Character	Keypad	Character	Keypad	Character
1	... 1	ABC 2	... A a B b C c 2	DEF 3	... D d E e F f 3
GHI 4	... G g H h I i 4	JKL 5	... J j K k L l 5	MNO 6	... M m N n O o 6
PRS 7	... P p Q q R r S s 7	TUV 8	... T t U u V v 8	WXY 9	... W w X x Y y Z z 9
* TONE	... *	OPER 0	... 0	#	... #

Direct Call Station Keys

1 Q q Z z ! +	5 _ - () < >	9 DELETE
2 = ` " , ?	6 [] { }	10 DISPLAY CLEAR
3 \$. @ → % /	7 SPACE	11 SECRET BACK SPACE
4 ¥ & : ^ ' ;	8 INSERT	12 HYPHEN

Character keys

Command keys

NOTE:

The character layout of the direct call station keys is printed on the reverse side of the directory card.

1. Remove the directory card cover with a pencil or similar object as shown.
2. Turn over the directory card. You will find the alphabet and symbol characters for each key on the directory card.

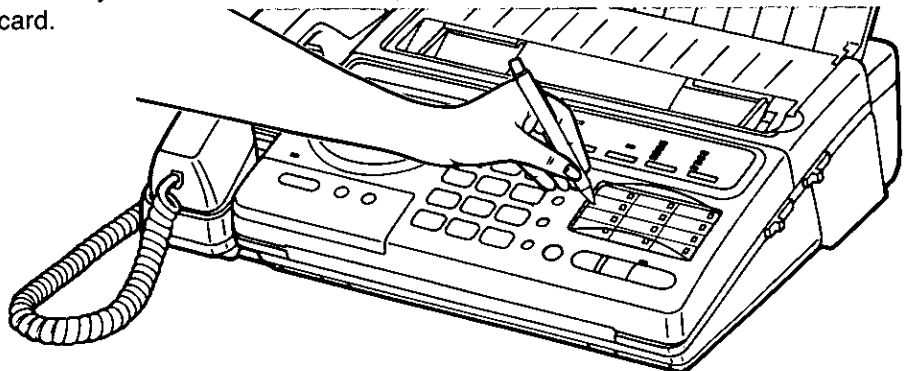

■ **Cursor keys**

◀ **key (LIGHT ORIGINAL button):**

The cursor is moved one space to the left each time you press this key.

▶ **key (RESOLUTION button):**

The cursor is moved one space to the right each time you press this key.

■ **Character keys**

The character on the display is changed as follows each time you press one of these keys.

For example, when you press 2 repeatedly, the display shows "A"→"a"→"B"→"b"→"C"→"c"→"2" → "A"...

To enter a character and move to the next character, press ▶ key (RESOLUTION button) once.

■ **Command keys**

DISPLAY CLEAR key:

You can clear all the characters.

SPACE key:

This key is used to replace one character to the space.

INSERT key:

This key is used to insert one character (or one space) in the programmed logo.

Example: Panaonic→Panasonic

1. Press ◀ key repeatedly until the cursor is positioned on "o".

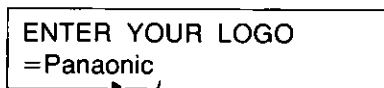

2. Press the **INSERT** key, then press 7 several times until "s" is shown.



DELETE key:

This key is used to delete one character from the programmed logo.

Example: Panassonic→Panasonic

1. Press ◀ key repeatedly until the cursor is positioned on "s".

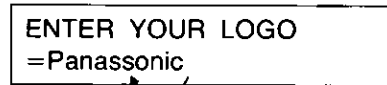

2. Press the **DELETE** key.

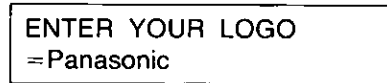

BACK SPACE key:

This key is used to delete one character to the left side of the cursor while it moves backward.

Example: Panasoinic→Panasonic

1. Press ◀ key repeatedly until the cursor is positioned on "n".

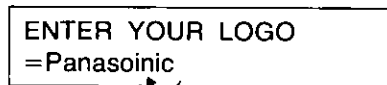

2. Press the **BACK SPACE** key.

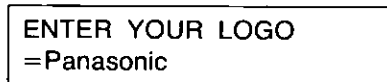

Individual transmission report setting

Each time a document is transmitted, this feature gives you a printed record of the transmission (XMT REPORT).

The following choices are available;

ERROR: The report is printed only when transmission fails (default).

ON: The report is printed, indicating whether the transmission is successful or not.

OFF: The report is not printed.

Sample of the transmission report:

Print time: Hour/Minute AM/PM
Print date: Month/Day/Year

```

***** XMT REPORT *****
*
*
* Jan. 01 1994 11:30AM *
*
* NO.   OTHER FACSIMILE   START TIME   USAGE TIME   MODE   PAGES   RESULT   CODE *
*-----*-----*-----*-----*-----*-----*-----*
* 01    1234567           Jan. 1 11:28AM  01'20       TX     02     OK
*
*
*
*
*****
  
```

Labels for the sample report:

- Communication number: 01
- Dialed number or other party's name: 1234567
- Communication start time: Jan. 1 11:28AM
- Length of communication: Minutes/Seconds: 01'20
- Transaction mode: TX... Transmission: TX
- Number of pages transmitted successfully: 02
- Communication result: OK

Explanation of communication result

OK:	Successful communication.
PRESSED THE STOP KEY:	The fax communication was interrupted since the STOP (⊖) button was pressed.
DOCUMENT JAMMED:	A document was jammed.
NO DOCUMENT:	The document was not fed into the unit properly.
PRINTER OVERHEATED:	Printing head was overheated.
PAPER OUT:	The unit was out of recording paper.
THE COVER WAS OPENED:	The front lid or back lid was opened.
COMMUNICATION ERROR:	Transmission or reception error.
PASSCODE FAILED:	Passcode communication failed.
NO RESPONSE:	Receiving unit is busy or out of recording paper.
PAPER JAMMED:	The recording paper was jammed.

To change the individual transmission report setting, proceed as follows:

1

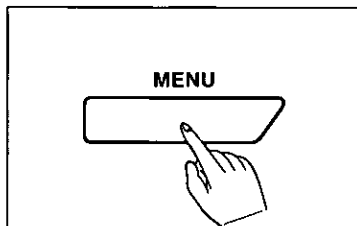

Press the **MENU** button until the following is shown.

PROGRAM[1.DATE 2.TEL
3.SYSTEM 4.REPORT]

2

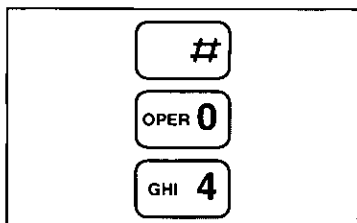

Press #, then press **04**.

XMT REPORT=ERROR
[1.ERROR 2.ON 3.OFF]

3

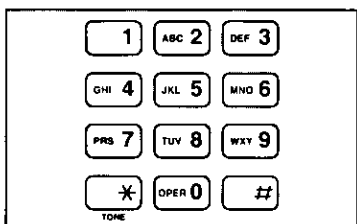

Press the number of the mode you desire.

Setting selections are:

- 1: ERROR
- 2: ON
- 3: OFF

4

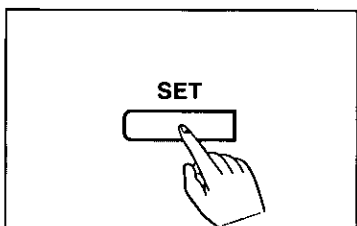

Press the **SET** button to store your selection in memory.

PROGRAM[1.DATE 2.TEL
3.SYSTEM 4.REPORT]

5

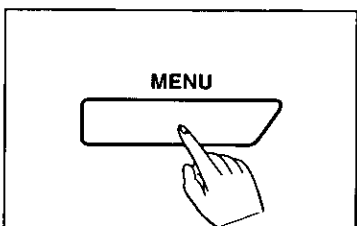

Press the **MENU** button to end the operation.

The display shows the current time.

Selecting the number of rings to answer in the ANS/FAX mode

When in the *ANS/FAX* mode, the unit will automatically answer on the first ring when receiving a call.

If you wish to change the number of rings to answer a call, you can choose among the following:

- 0: Toll Saver (see page 2-13)
- 1: The unit answers on the first ring (default).
- 2: The unit answers on the second ring.
- 3: The unit answers on the third ring.
- 4: The unit answers on the fourth ring.
- *: The unit will not ring. (RINGER OFF)

HELPFUL HINTS:

- If you wish to have the opportunity to pick up the handset before the call is answered by the unit, set the number of rings to "3" or "4".
- If you find there is difficulty in fax receiving from machines that have an automatic transmission feature, set the number of rings to "1".
- To confirm from the remote phone whether a new incoming message has been recorded or not (see pages 5-23 to 5-28), select the Toll Saver position. This will save you the toll charge for the call.

To change the ANS/FAX RING COUNT, proceed as follows:

1

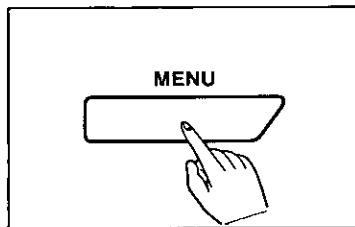

Press the **MENU** button until the following is shown.

PROGRAM[1.DATE 2.TEL
3.SYSTEM 4.REPORT]

2

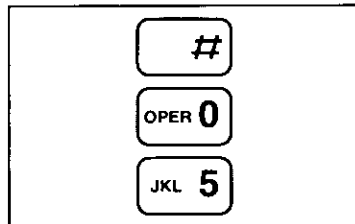

Press #, then press **05**.

ANS/FAX RING
COUNT=1 [0-4, *]

3

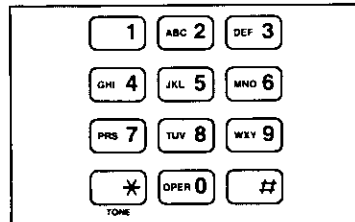

Press the number of the selection you desire.

Setting selections are:

- 0: Toll Saver
- 1: one ring
- 2: two rings
- 3: three rings
- 4: four rings
- *: Ringer Off

4

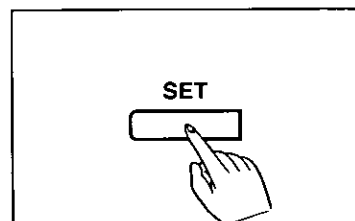

Press the **SET** button to store your selection in memory.

PROGRAM[1.DATE 2.TEL
3.SYSTEM 4.REPORT]

5

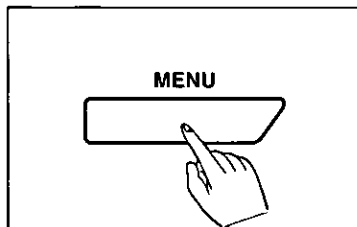

Press the **MENU** button to end the operation.

The display shows the current time.

Toll Saver:

When you call the unit from a remote location, the number of rings tells you if there are any new voice-messages.

If the unit answers on the first ring, there is at least one new message recorded.

If the unit answers on the third ring, there are no new messages recorded.

Hang up immediately when you hear the second ring. The second ring indicates that there are no new messages. This will save you the toll charge for the call.

NOTE:

If you set the RINGER OFF through the ANS/FAX RING COUNT function, the extension phone connected to the unit will ring once when receiving a call.

Selecting the number of rings to answer in the FAX mode

When in the *FAX* mode, the unit will automatically answer on the first ring when receiving a call. If you wish to change the number of rings to answer a call, you can choose the number among "1" (one ring) through "4" (four rings).

HELPFUL HINTS:

- If you wish to have the opportunity to pick up the handset before the call is answered by the unit, set the number of rings to "3" or "4".
- If you find there is difficulty in fax receiving from machines that have an automatic transmission feature, set the number of rings to "1".

To change the FAX RING COUNT, proceed as follows:

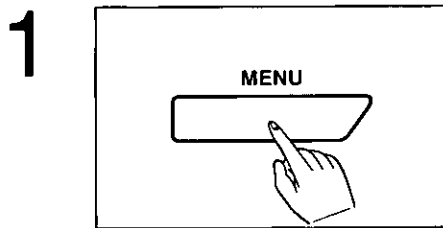

Press the **MENU** button until the following is shown.

PROGRAM[1.DATE 2.TEL
3.SYSTEM 4.REPORT]

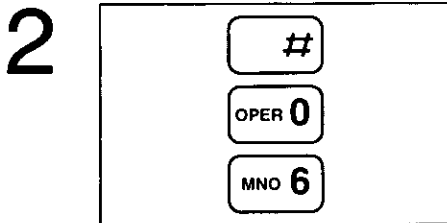

Press #, then press **06**.

FAX RING COUNT=1
[1-4]

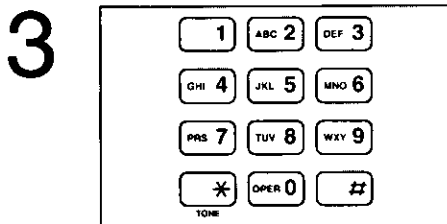

Press the number of the selection you desire.

Setting selections are:

- 1: one ring
- 2: two rings
- 3: three rings
- 4: four rings

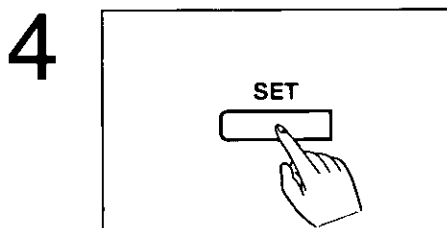

Press the **SET** button to store your selection in memory.

PROGRAM[1.DATE 2.TEL
3.SYSTEM 4.REPORT]

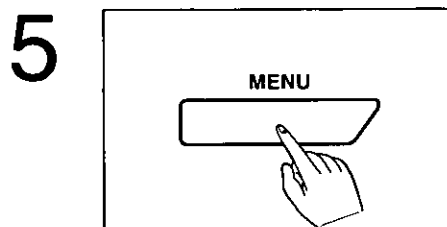

Press the **MENU** button to end the operation.

The display shows the current time.

Selecting the caller's recording time

You can choose from two lengths of recording times for incoming messages.

VOX: The unit records an incoming message as long as a caller speaks (default).

1 MIN: The unit records an incoming message up to 1 minute per message.

To change the recording time, proceed as follows:

1

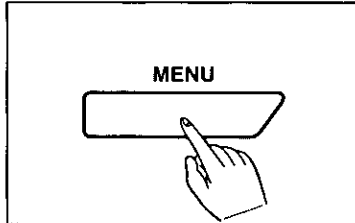

Press the **MENU** button until the following is shown.

PROGRAM[1.DATE 2.TEL
3.SYSTEM 4.REPORT]

2

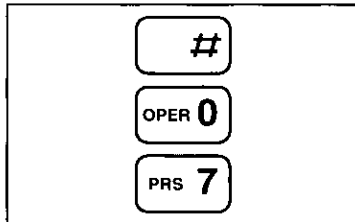

Press #, then press **07**.

RECORD TIME=VOX
[1.VOX 2.1MIN]

3

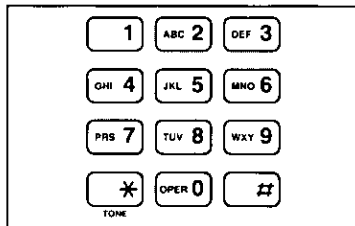

Press the number of the selection you desire.

Setting selections are:

1: VOX (unlimited)

2: 1 MIN (1 minute)

4

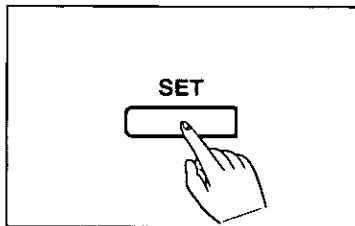

Press the **SET** button to store your selection in memory.

PROGRAM[1.DATE 2.TEL
3.SYSTEM 4.REPORT]

5

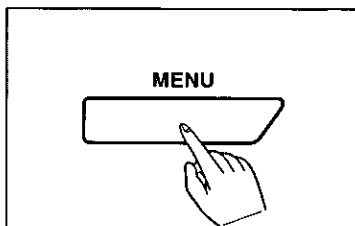

Press the **MENU** button to end the operation.

The display shows the current time.

Setting the remote code (REMOTE ANS ID) for remote operation

The REMOTE ANS ID is used to access your answering device from a remote location with a touch tone phone (see pages 5-23 to 5-28).

Using this code, you can retrieve incoming messages recorded on the microcassette tape from a remote location.

The REMOTE ANS ID is preset to "111". If you wish to change the number, you can choose any number from "111" to "999" except numbers including "0".

Make sure that the first 2 digits of the REMOTE ANS ID number is different from the JUNK MAIL PROHIBITOR ID number (see pages 5-9 and 5-10).

1

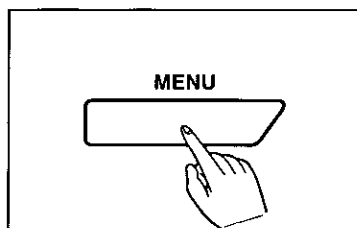

Press the **MENU** button until the following is shown.

PROGRAM[1.DATE 2.TEL
3.SYSTEM 4.REPORT]

2

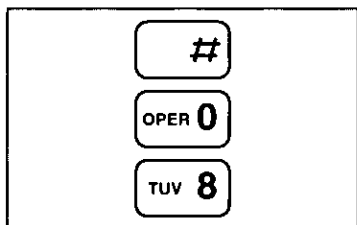

Press #, then press **08**.

ENTER YOUR REMOTE
ANS ID=111

3

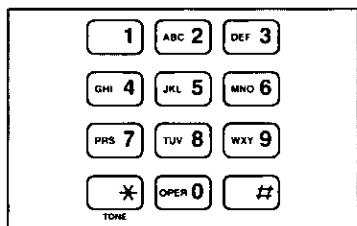

Enter the desired REMOTE ANS ID using the dial keypad.

Example: The REMOTE ANS ID is 456.

ENTER YOUR REMOTE
ANS ID=456

4

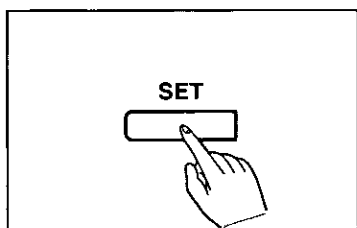

Press the **SET** button to store your selection in memory.

PROGRAM[1.DATE 2.TEL
3.SYSTEM 4.REPORT]

5

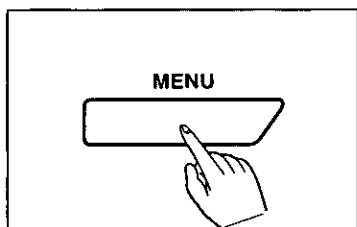

Press the **MENU** button to end the operation.

The display shows the current time.

NOTES:

- We recommend that you do not use seven (7) as a code number, since this number is used as the greeting message re-recording command for remote operations.
- If you make a mistake in step 3, use the cursor key (▶ or ◀) to move the cursor to the incorrect number, then make the correction.

HELP Function —If you have lost your procedures—

The HELP button is used to print information about how to send documents, how to set up your unit and how to store phone numbers.

Using the HELP button

- Press the **HELP** button when the unit is in the idle status.
The following is printed out.

<<SENDING A FAX>>

1. INSERT DOCUMENT FACE DOWN.
2. PRESS "SP-PHONE". (LIGHTS)
3. DIAL FAX NUMBER OF PARTY YOU WISH TO SEND TO.
4. WAIT FOR FAX TONE THEN PRESS "START". (SP-PHONE LIGHT GOES OFF)

<<SETTING UP YOUR UNIT>>

1. PRESS "MENU" TWO TIMES.
2. PRESS "#" THEN THE NUMBER OF THE FEATURE YOU WISH TO SET USING THE DIAL KEY-PAD. (SEE BASIC FEATURE LIST BELOW)
3. ENTER CHOICE OR DATA.
4. IF YOU ENTERED #99 PRESS "START", OTHERWISE PRESS "SET" TO STORE YOUR SELECTION.
5. PRESS "MENU" TO END SET UP.

<BASIC FEATURE LIST>

#01 SET DATE = Jan. 01 1994 12:00AM
#02 YOUR LOGO (I.E. COMPANY OR INDIVIDUAL NAME)
=
#03 YOUR TELEPHONE NUMBER =
#04 PRINT TRANSMISSION REPORT = ERROR [1=ERROR 2=ON 3=OFF]
#05 ANS/FAX RING COUNT = 1 [1...4 0=TOLL SAVER *=RINGER OFF]
#06 FAX RING COUNT = 1 [1...4]
#07 RECORDING TIME FOR ANS = VOX [1=VOX 2=1MIN]
#08 REMOTE ANS ID = 111
#09 PRINT ADVANCED FEATURE LIST

1. INSERT DOCUMENT FACE DOWN.
2. PRESS ANY DIRECT CALL STATION OR PRESS "START" (TO MAKE A PHONE CALL)
1. LIFT HANDSET OR PRESS "SP-PHONE".
2. PRESS ANY DIRECT CALL STATION OR PRESS "AUTO" AND 2-DIGIT NUMBER. (00 TO 99)

<<HOW TO RECORD A GREETING MESSAGE>>

1. OPEN "ANSWERING CONTROL" PANEL.
2. PRESS "REC".
3. SPEAK INTO THE MICROPHONE. (UP TO 16 SEC)
4. WHEN FINISHED, PRESS "STOP" OR "REC" AGAIN.

<<PRIOR TO LEAVING>>

CONFIRM THAT THE ANS/FAX INDICATOR IS LIT.

<<HOW TO PLAYBACK ONLY NEW MESSAGES>>

PRESS "NEW MESSAGES".

<<HOW TO PLAYBACK ALL THE RECORDED MESSAGES>>

PRESS "ALL MESSAGES".

<<SETTING THE OVERSEAS TRANSMISSION MODE>>

1. PRESS "OVERSEAS".
2. TRANSMISSION SPEED IS SET TO 4800 BPS.

- Press the **HELP** button while programming each feature (#01 through #08, #10 and #11).

Example: When you wish to program the SET DATE (#01),

1. Press the **MENU** button until the following is shown.
The display shows;

```
PROGRAM[1.DATE 2.TEL  
3.SYSTEM 4.REPORT]
```

2. Press 1 for SET DATE setting.
The display shows;

```
SET DATE [*=AM #=PM]  
01 01 94 12:00AM SAT
```

3. When you wish to know how to continue programming, press the **HELP** button.
The following is printed out.

```
<<SETTING THE CLOCK>>  
1. ENTER THE MONTH, DAY, YEAR, HOUR AND MINUTE USING THE DIAL KEY-PAD.  
PRESS THE "*" KEY TO ENTER AM AND PRESS THE "#" KEY TO ENTER PM.  
2. PRESS "SET" TO STORE.
```

4. Resume programming.

Chapter 3

Basic Instructions

Table of contents

<i>Facsimile and Copier</i>		<i>Answering Device</i>	
Before Transmitting Documents	3-2	Operating as an Answering Device	3-12
Acceptable documents	3-2	Setup of voice message and document reception	3-13
Documents you cannot send	3-2	Listening to newly recorded messages	3-13
Resolution and contrast	3-3	Listening to all the recorded messages	3-14
Loading documents	3-3	Recording after the messages you want to save	3-14
Transmitting Documents	3-4	Monitoring incoming calls	3-15
Manual transmission	3-4	Recording a memo message	3-15
Adding extra pages	3-5	Recording a telephone conversation (2-way recording)	3-16
Receiving Documents and/or Voice Calls	3-6		
Manual reception	3-6		
Automatic reception	3-7		
Receiving in the ANS/FAX mode	3-7		
Receiving in the TEL/FAX mode	3-8		
Receiving in the FAX mode	3-8		
Transmitting Documents to Your Unit	3-9		
Leaving a message and transmitting documents on the same call	3-9		
Transmitting documents with manual operation	3-10		
Making a Copy	3-11		
		<i>Telephone</i>	
		Making and Answering Voice Calls	3-17
		Making voice calls	3-17
		Redialing the last dialed number	3-18
		Answering voice calls	3-18

Basic Instructions

When the display shows any error message, see page 7-2 for corrective measures.

Before Transmitting Documents

Acceptable documents

The unit can transmit documents that meet the following conditions.

- Documents width should be from 128 mm (5") to 216 mm (8½").
- Maximum document length should not exceed 600 mm (23⅝").
- Effective scanning width can be up to 208 mm (8⅜").
- Number of pages that can be set in the document feeder tray can be up to 10 sheets.
- Document weight:
 - Single sheet: 45 g/m² to 90 g/m² (12 pound to 24 pound)
 - Multiple sheets: 60 g/m² to 75 g/m² (16 pound to 20 pound)

Minimum document size

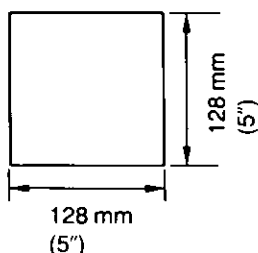

Maximum document size

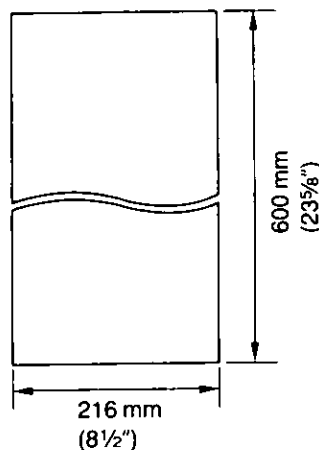

Effective scanning width

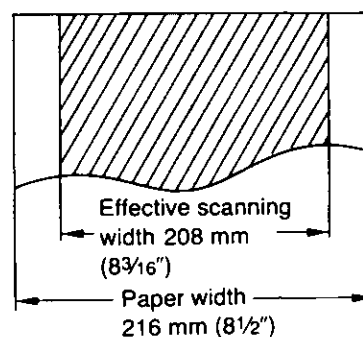

NOTES:

- A document whose length exceeds 600 mm (23⅝") cannot be transmitted. When you feed such documents, the unit will stop transmitting and a long beep will be heard. If this happens, press the **STOP** (⏏) button and remove the document.
- If a document is electrostatically charged, the automatic document feeder may not function properly.

Documents you cannot send

Do not use the following types of documents or they may jam. Make a copy of such documents and feed the copy into the unit.

- Paper with a chemically treated surface such as carbon paper or carbonless duplicating paper
- Heavily curled, creased or torn paper
- Paper with a coated surface
- Small-sized paper such as a slip or voucher
- Thin paper less than 45 g/m² (12 pound)
- Thick paper over 90 g/m² (24 pound)
- Paper with faint contrast between the print and the background
- Paper with printing on the reverse side that can be seen through from the front (e.g. newspaper)

Resolution and contrast

You can set the following functions depending on the quality of an original. Set the functions before transmission or copying. If you set them during transmission, they will be effective from the next sheet transmitted.

RESOLUTION:

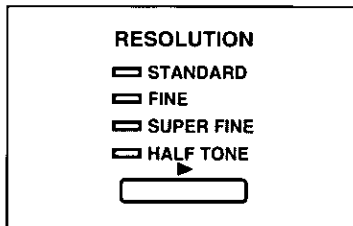

STANDARD is suitable for printed or typewritten originals with normal-sized characters.

FINE is suitable for originals with small printing.

SUPER FINE doubles the resolution of FINE.

(SUPER FINE only works between other KX-F280s or other Panasonic compatible machines.)

HALF TONE is useful when sending originals containing photographs, shaded drawings, etc.

LIGHT ORIGINAL:

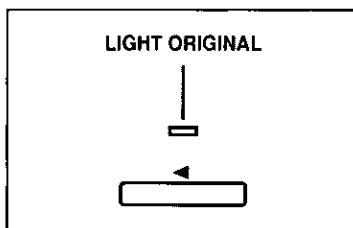

LIGHT ORIGINAL is useful when transmitting or copying originals with faint writing.

This feature does not work in the HALF TONE resolution.

Loading documents

Remove clips, staples or other similar objects from a document before feeding it into the unit. Check that all ink, paste or connection fluid on the document is completely dry before feeding it into the unit.

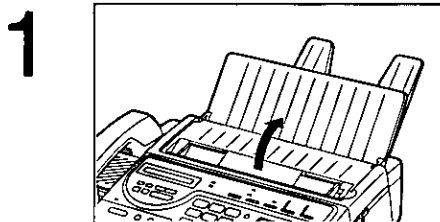

Open the document feeder tray.

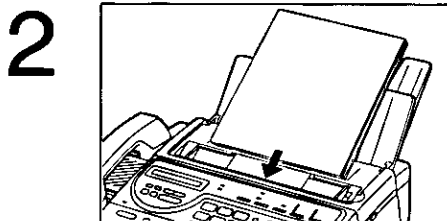

Insert the documents **FACE DOWN** into the document feeder tray.

The unit can accept up to 10 sheets of paper at a time.

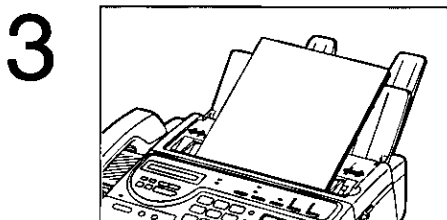

Adjust the document guides to the width of the document.

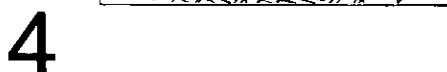

Set the resolution or contrast setting if needed.

Transmitting Documents

Manual transmission

1

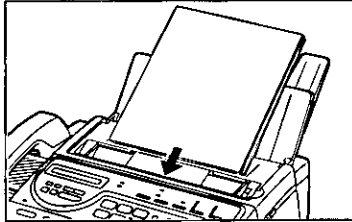

Insert the documents **FACE DOWN**.

The unit can accept up to 10 sheets of paper at a time.

2

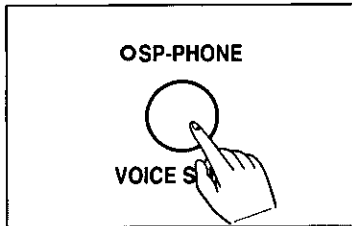

Press the **SP-PHONE** button or lift the handset.

SAT JAN 1 3:00PM 00
ENTER PHONE NUMBER

3

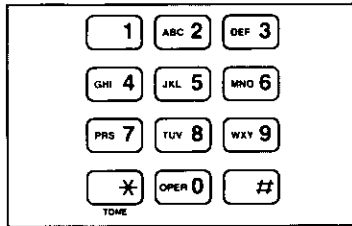

Dial the phone number of the party to which you wish to send.

SAT JAN 1 3:00PM 00
1234567

If the other party answers, ask them to press their start or transmit button to start the fax reception.

4

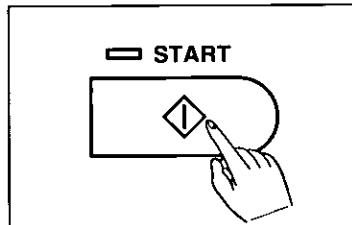

Press the **START** button when a fax tone is heard.

SENDING P1
TO:1234567

5

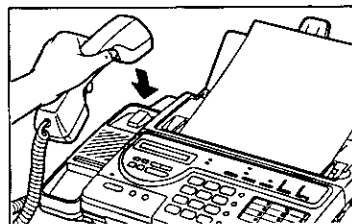

Place the handset on the cradle if using it.

The unit will feed and transmit the documents.
The display will show the number of each page (01 through 99) during a fax transmission.

NOTES:

- If you do not replace the handset after pressing the **START** button, the unit will automatically call the other party upon finishing the transmission. For further details, see "Voice Contact" on page 5-30.
- If the line is busy, press the **SP-PHONE** button or hang up the handset if using it. Then try again later by using the **REDIAL** button in step 3 on this page instead of dialing the phone number.
- To interrupt transmission, press the **STOP** (⏏) button until a beep sounds. Press the **STOP** (⏏) button again to eject the document.

You can also access the other party's facsimile without using the handset or the **SP-PHONE** button.

This feature enables you to transmit a document in less procedures.

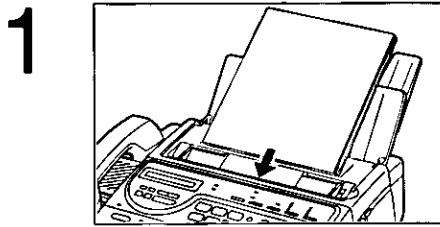

Insert the documents **FACE DOWN**.

The unit can accept up to 10 sheets of paper at a time.

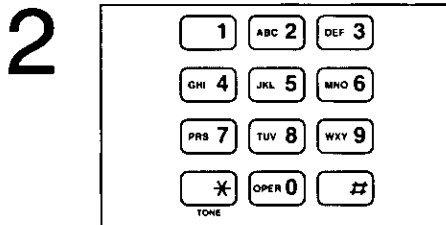

Enter the phone number of the party to which you wish to send.

Example: 1234567 is dialed.

SAT JAN 1 3:00PM 00
1234567

Confirm in the display whether the phone number is correctly dialed. If you misdialed, press the **STOP** (Ⓢ) button then enter the correct number.

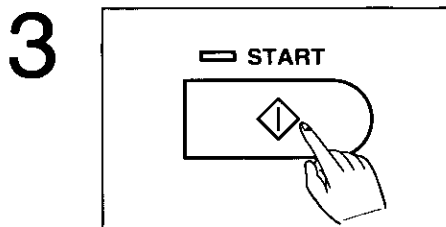

Press the **START** button.

The unit dials and transmits the documents.

DIALING <XMT>
TO:1234567



SENDING P1
TO:1234567

Automatic redialing feature:

If there is no answer or the line is busy, the unit will automatically redial the number up to 5 times.

While waiting for the redialing, the display will show,

SAT JAN 1 3:00PM 00
WAITING TO REDIAL

To cancel automatic redialing, press the **STOP** (Ⓢ) button.

NOTE:

To interrupt transmission, press the **STOP** (Ⓢ) button until a beep sounds. Press the **STOP** (Ⓢ) button again to eject the document.

Adding extra pages

If you want to send 11 or more sheets at a time, insert the first ten pages of the document and add the extra pages, up to 10 sheets at a time, before the last page is fed into the unit.

Receiving Documents and/or Voice Calls

Manual reception

When in the *TEL* mode or during a telephone conversation, you can receive fax documents as follows.

1

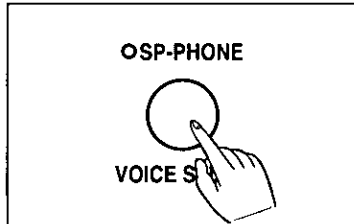

When the phone rings, lift the handset or press the **SP-PHONE** button to answer the call.

2

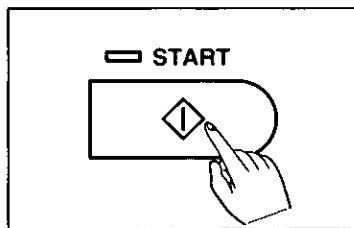

When a voice is heard and document reception is required, press the **START** button.

3

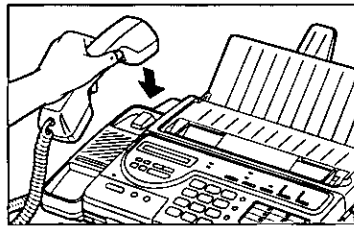

Place the handset on the cradle if using it.

The unit starts receiving a document.

RECEIVING P1
FROM:<G3>

The display shows the number of each page (01 through 99).

NOTES:

- If you do not replace the handset after pressing the **START** button, the unit will automatically call the other party. For further details, see "Voice Contact" on page 5-30.
- To interrupt reception, press the **STOP** (⏏) button. The unit will stop receiving.
- Replace the paper roll with a new one;
 - when the red lines appear on both sides of the recording paper.
 - when the PAPER OUT indicator lights.
 - when the display shows "OUT OF PAPER".

Automatic reception

Set the **RECEIVE MODE** to any of the following modes:

- ANS/FAX mode
- TEL/FAX mode
- FAX mode

When receiving a fax call, the unit will automatically switch to the fax mode, then initiate reception. If you press the SP-PHONE button or lift the handset during receiving a document, the unit will automatically call the other party. For further details, see "Voice Contact" on page 5-30.

Receiving in the ANS/FAX mode

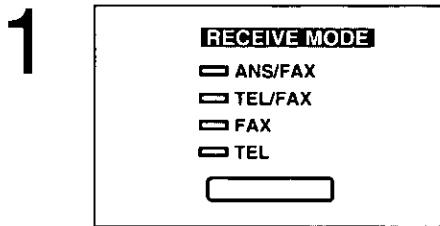

Make sure that the unit is in the *ANS/FAX* mode.

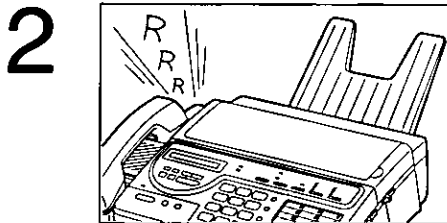

A call comes in.

The unit answers the call after 1 to 4 rings or no rings, depending on the number of rings after which the unit is set to answer (see page 2-12).

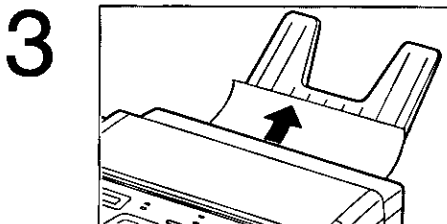

—When receiving a fax tone, the unit automatically activates the fax function to receive documents.

—When receiving a voice-call, the unit plays your greeting message.

NOTES:

- Begin by transmitting the FAX CORRESPONDENCE leaflet found on page 8-11 to several of your associates. In this way you can confirm that your unit is functioning correctly and inform them of the procedure for transmitting documents and/or recording voice-message on your unit.
- If you set the RINGER OFF through the ANS/FAX Ring Count function, the extension phone connected to the unit will ring once when receiving a call. See page 2-12 for the RINGER OFF setting.

Receiving in the TEL/FAX mode

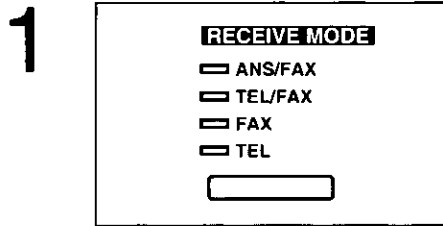

Make sure that the unit is in the *TEL/FAX* mode.

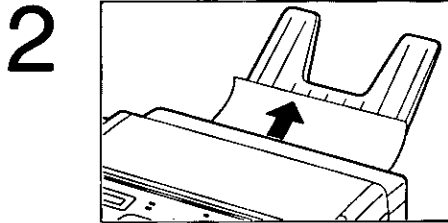

A call comes in.

—When receiving a fax tone, the unit automatically activates the fax function to receive documents.

or

or



—When receiving a telephone call, the unit rings 3 to 8 times, depending on the setting of the silent fax recognition ring (see page 5-35).

If a fax reception is required or nothing is heard, press the **START** button and hang up to receive a fax.

If someone does not pick up the phone, the unit automatically activates the fax function.

NOTES:

- A telephone fee is charged to callers from the first ring.
- When a call comes in, an extension phone, if connected on the same line, will ring 1 to 4 times depending on the setting of the FAX RING COUNT (see page 2-14) before the unit rings or initiates fax reception.

Receiving in the FAX mode

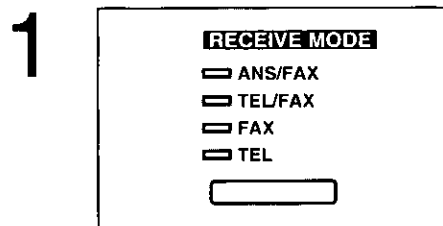

Make sure that the unit is in the *FAX* mode.

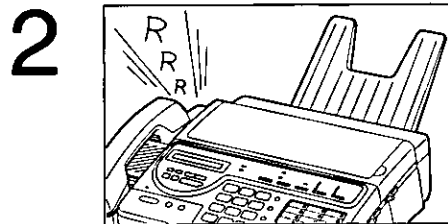

A call comes in.

The unit answers the call after 1 to 4 rings, depending on the number of rings after which the unit is set to answer (see page 2-14).

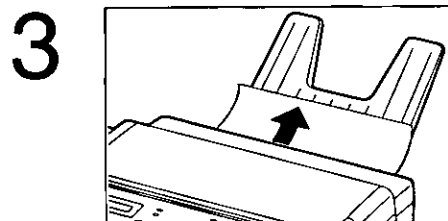

The unit produces a fax tone, then starts receiving a document when the other party presses their start or transmit button.

Transmitting Documents to Your Unit

Leaving a message and transmitting documents on the same call

When the unit is in the *ANS/FAX* mode, your caller can follow the steps below to leave a message and send documents.

From a touch tone phone:

1



Your caller may call your unit, and then leave you a message after the long beep following your greeting message.

2

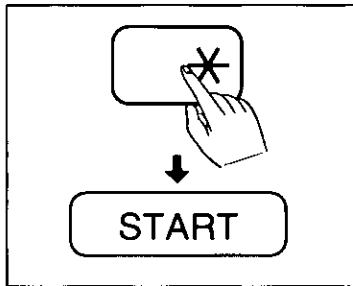

When their message is finished, they may press * to change the unit to the fax mode.

They then may start transmission upon hearing the fax tone by pressing their start or transmit button.

From a rotary (pulse) phone:

If the calling facsimile machine has a voice contact (call reservation) function, your caller can leave a voice-message after transmitting documents to your facsimile.

1



Your caller may call your unit, and then press the mute button or cover the mouthpiece of their handset to change the unit to the fax mode during the greeting message.

2



They then may start transmission upon hearing the fax tone by pressing their start or transmit button.

3



They may make a call reservation (e.g. lift the handset) during transmission.

Your unit plays the greeting message again.

They then may leave a message after the long beep following your greeting message.

Transmitting documents with manual operation

From a touch tone phone:

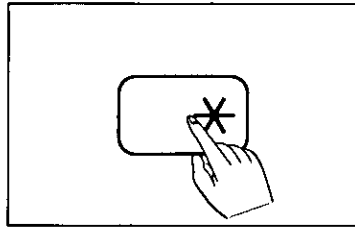

Your caller may call your unit, and then press * to change the unit to the fax mode.

They then may start transmission upon hearing the fax tone by pressing their start or transmit button.

From a rotary (pulse) phone:

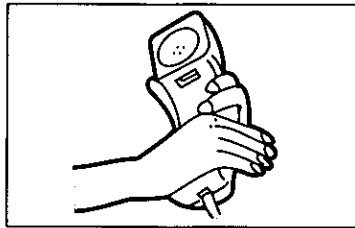

Your caller may call your unit, and then press the mute button or cover the mouthpiece of their handset to change the unit to the fax mode during the greeting message.

They then may start transmission upon hearing the fax tone by pressing their start or transmit button.

Making a Copy

The unit can make a copy. Any transmissible documents can be copied.
Before sending a document, you can see how it will look to the receiving party in advance.

When copying, the unit automatically selects the **FINE** resolution, but you may use **SUPER FINE** or **HALF TONE** resolution.

1

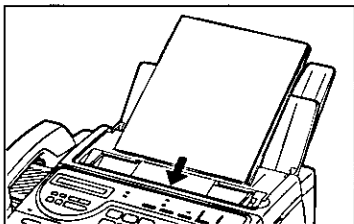

Insert the documents **FACE DOWN**.

2

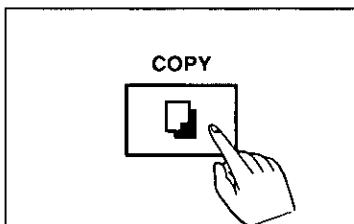

Press the **COPY** button.

The unit starts making a copy.

NOTES:

- If you wish to copy 11 or more sheets at a time, insert the first ten pages of the document and add the extra pages up to 10 sheets at a time, before the last page is fed into the unit.
- You can make or receive voice calls while making a copy.
- To stop making a copy on the way, press the **STOP** (⏏) button. The unit stops copy operation. Press the **STOP** (⏏) button again to eject the document.
- When the Paper Save function is on and the **STANDARD** resolution is selected, the unit will make a copy half the size of the original (see page 5-19).

Operating as an Answering Device

The unit also works as an automatic telephone answering and recording system.

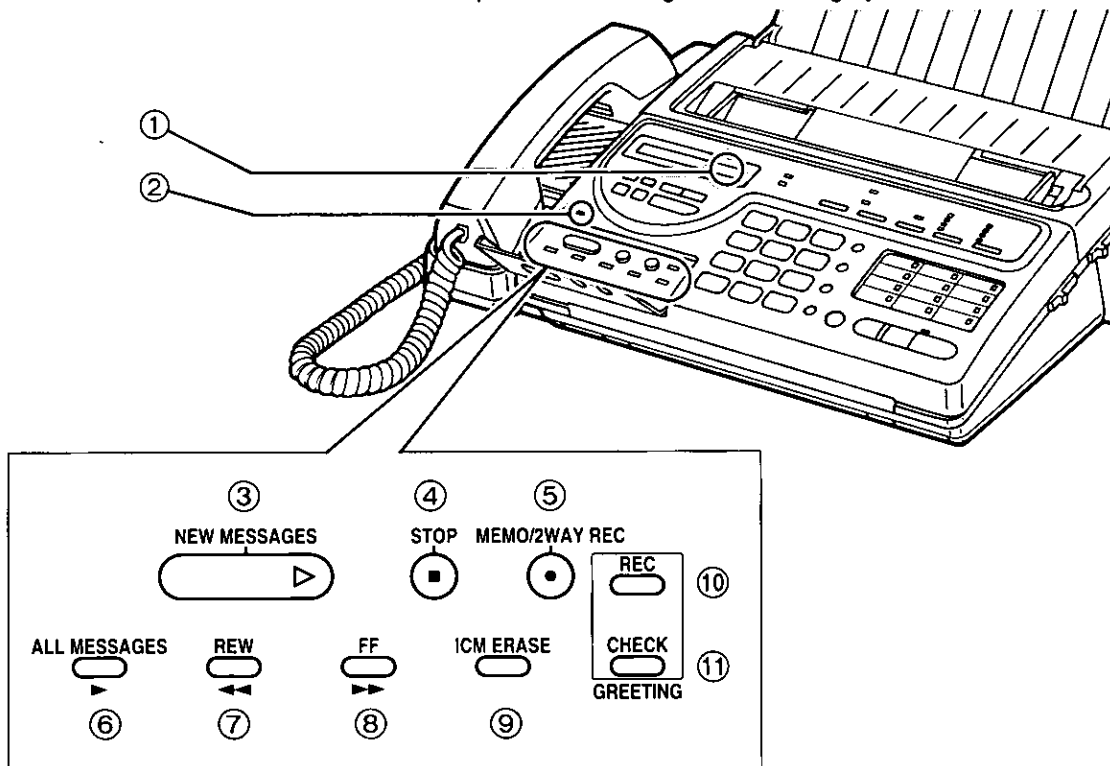

- ① **Call counter:**
The number of recorded incoming voice-messages is shown on the display.

If the power supply has been interrupted, the call counter shows "--" when the power is restored.
- ② **Indicator:**
When any new incoming messages are recorded, the indicator flashes.
- ③ **Playing back newly recorded voice-messages:**
Press the **NEW MESSAGES** button (see page 3-13).
- ④ **Stopping operations of the answering device:**
Press the **STOP** (■) button.
- ⑤ **Recording a memo message:**
See page 3-15.

Recording a telephone conversation:
See page 3-16.
- ⑥ **Playing back all recorded messages:**
Press the **ALL MESSAGES** button (see page 3-14).
- ⑦ **Rewinding (Resetting) the tape quickly:**
Press the **REW** (rewind) button.
- ⑧ **Advancing the tape quickly:**
Press the **FF** (fast forward) button.
- ⑨ **Erasing recorded voice-messages:**
After reviewing messages to you, press the **ICM ERASE** button. The messages are erased while the tape is rewound.

The tape can be erased at high speed even if the record-prevention (knock-out) tabs have been removed.
- ⑩ **Recording your greeting message:**
See page 1-16.
- ⑪ **Checking your greeting message:**
See page 1-17.

Setup of voice message and document reception

1

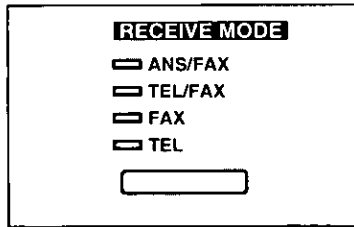

Press the **RECEIVE MODE** button until the ANS/FAX indicator lights.

2

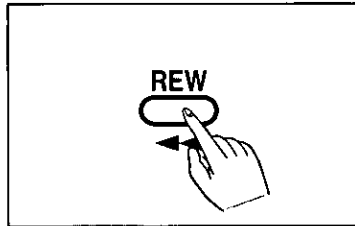

Press the **REW** button to record messages from the beginning of the tape.

When a call is received, the unit answers the call and begins playback of your greeting message. The unit automatically distinguishes between voice and fax calls, and then functions as an answering device and/or a facsimile.

NOTE:

The recording time for incoming messages can be set to VOX (unlimited) or 1 MIN (1 minute). It is preset to VOX. To change the recording time, see page 2-15.

Listening to newly recorded messages

When new incoming messages have been recorded, the call counter shows the number of recorded messages (01 to 99) and the  indicator flashes.

To play back only new messages:

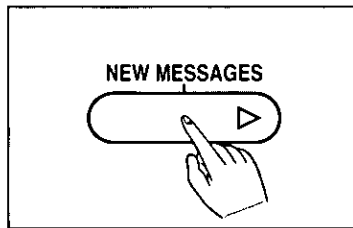

Press the **NEW MESSAGES** button.

SAT JAN 1 3:00PM 02
ICM PLAYING >>>>>>

The unit plays back new messages.
At the end of the last message, 3 beeps sound and the tape stops automatically.

NOTES:

- The unit is equipped with the Message Alert feature. When this feature is on, the unit lets you know with a slow beep whether a caller's message has been recorded in the unit or not. To set the Message Alert, see page 5-29.
- To interrupt the playback halfway, press the **STOP (■)** button.
To restart the playback, press the **NEW MESSAGES** button within one minute after pressing the **STOP (■)** button. Or the unit will record over any existing messages.

Listening to all the recorded messages

All the recorded messages will be played back from the beginning of the tape.

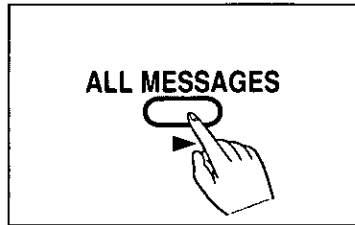

Press the **ALL MESSAGES** button.

SAT JAN 1 3:00PM 02
ICM PLAYING >>>>>>

The unit plays back all the recorded messages. At the end of the last message, 3 beeps sound and the tape stops automatically.

NOTE:

To interrupt the playback halfway, press the **STOP** (■) button.

To restart the playback, press the **ALL MESSAGES** button within one minute after pressing the **STOP** (■) button. Or the unit will record over any existing messages.

Recording after the messages you want to save

New incoming messages will be automatically stored after the last message. If you want to store incoming messages after your saved messages, proceed as follows.

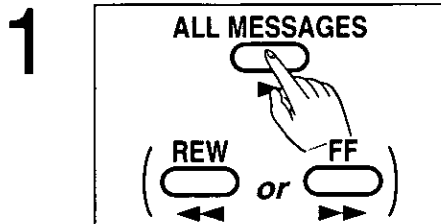

Play back the messages.

You may use the **ALL MESSAGES**, **FF** or **REW** button.

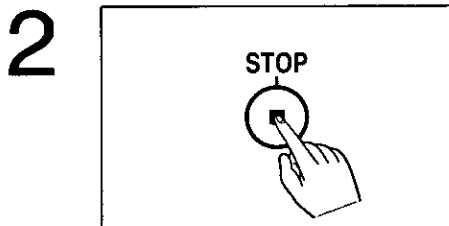

Press the **STOP** (■) button at the end of the messages you want to save.

SAT JAN 1 3:00PM 00

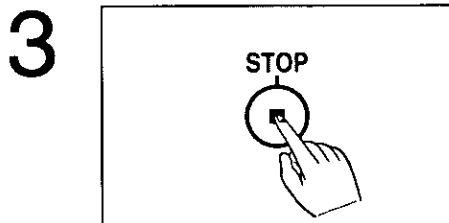

Press the **STOP** (■) button again.
or
Leave the unit for one minute.

SAT JAN 1 3:00PM 00

Future calls will be recorded after the message(s) you have saved.

Monitoring incoming calls

While an incoming message is being recorded, you can monitor the caller's voice through the built-in speaker and answer it if you want.

Adjust the sound level using the **VOLUME** control.

To answer the call while monitoring, lift the handset or press the **SP-PHONE** button. The unit stops recording automatically.

Recording a memo message

If you are going out and want to leave a private message for someone, you can record a voice memo in the unit. This can then be played back either directly or remotely, exactly like any other incoming message.

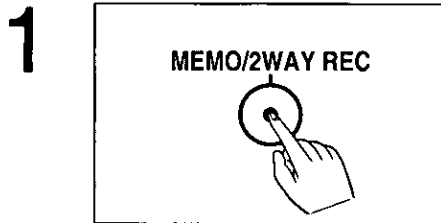

Press the **MEMO/2WAY REC** button.

A beep is heard.

SAT JAN 1 3:00PM 00
MEMO RECORDING

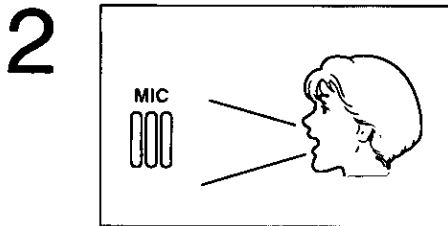

Speak toward the microphone from approximately 20 cm (8 inches) away.

SAT JAN 1 3:00PM 00
MEMO RECORDING

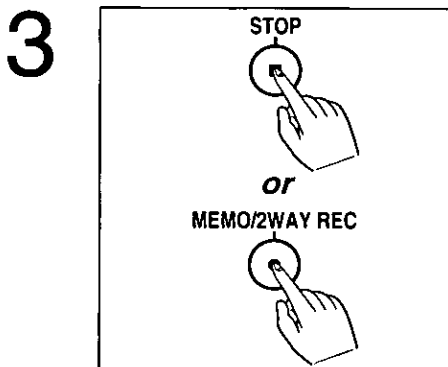

To stop recording, press the **STOP** (■) button or the **MEMO/2WAY REC** button again.

SAT JAN 1 3:03PM 01

The call counter on the display increases by one and the  indicator flashes.

Recording a telephone conversation (2-way recording)

While speaking with someone on the telephone, you can record your conversation.

1

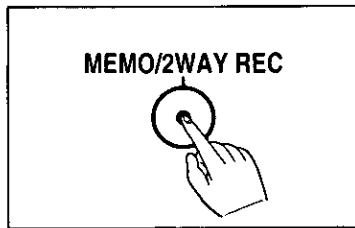

During your conversation, press the **MEMO/2WAY REC** button.

A beep is heard.

SAT JAN 1 3:00PM 00
2WAY RECORDING

2



Continue your conversation.

SAT JAN 1 3:00PM 00
2WAY RECORDING

3

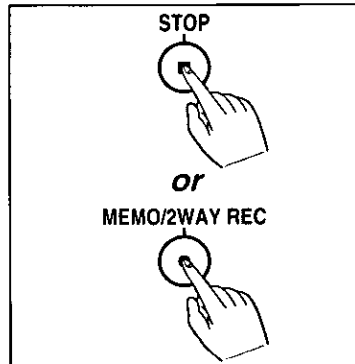

To stop recording, press the **STOP** (■) button or the **MEMO/2WAY REC** button again.

SAT JAN 1 3:03PM 01

The call counter on the display increases by one and the  indicator flashes.

NOTE:

There may be imposed regulations in your area (state) concerning the manner in which 2-way telephone conversations may be recorded. So you should inform the other party that the conversation is being recorded. Consult your local telephone company for further information.

Making and Answering Voice Calls

Making voice calls

Using the handset

1. Lift the handset.
2. Dial the phone number.

Using the speaker phone

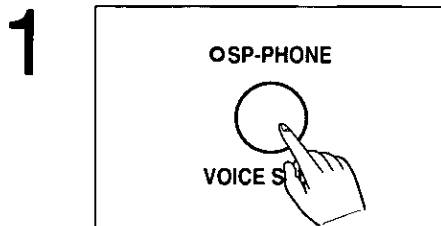

Press the **SP-PHONE** button.

The SP-PHONE indicator lights.

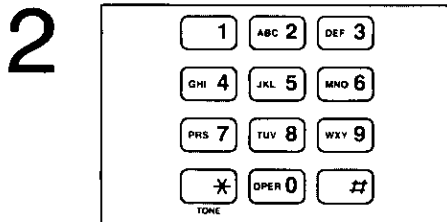

Dial the phone number.

The dialed number is displayed.

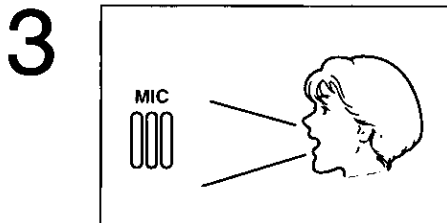

When the other party answers, speak with them through the Microphone (MIC).

To switch to the handset, lift the handset.

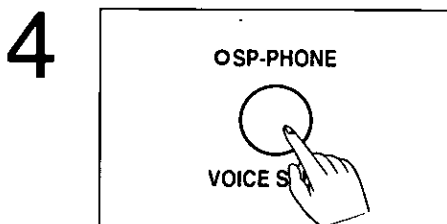

When finished, press the **SP-PHONE** button.

Replace the handset on the cradle if using it.

HELPFUL HINTS FOR THE SPEAKER-PHONE OPERATION:

- Use the speakerphone in a quiet room for best performance.
- If the other party has difficulty hearing you, decrease the volume using the **VOLUME** control (see page 1-5).
- If you and the other party speak at the same time, parts of your conversation will be lost. To avoid this, speak alternately.

Redialing the last dialed number

If the line is busy or you wish to redial the last dialed number, you can redial by pressing the **REDIAL** button.

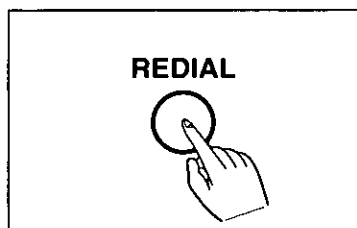

Press the **REDIAL** button.

- When using the handset**, the unit redials the last dialed number once.
- When using the speaker phone**, the unit redials the last dialed number.

If the line is busy, the unit will automatically redial the number up to 14 times (9 times for KX-F280C/Canadian version). The **SP-PHONE** indicator will flash and the following display will be shown while waiting for the redialing.

SAT JAN 1 3:00PM 00
WAITING TO REDIAL

To cancel automatic redialing, press the **STOP** (⏏) button.

Answering voice calls

When the phone rings, lift the handset or press the **SP-PHONE** button to answer the call.

When you have finished, replace the handset or press the **SP-PHONE** button.

NOTE:

For helpful hints for speakerphone operation, see page 3-17.

Chapter 4

Intermediate Instructions

Table of contents

Storing Phone Numbers for Automatic Dialing	4-2
Filling in the directory card	4-2
Storing phone numbers for one touch dialing	4-3
Storing phone numbers for speed dialing	4-5
Storing secret phone numbers	4-7
Electric Telephone Directory	4-9
How to use the Electric Telephone Directory	4-10
<i>Facsimile</i>	
Transmitting Documents Using Automatic Dialer	4-11
Transmitting Documents Using Electric Telephone Directory	4-12
<i>Telephone</i>	
Making Voice Calls Using Automatic Dialer	4-13
Making Voice Calls Using Electric Telephone Directory	4-14

When the display shows any error message, see page 7-2 for corrective measures.

Storing Phone Numbers for Automatic Dialing

The unit's memory allows you to use both one touch dialing (up to 12 phone numbers) and speed dialing (up to 100 phone numbers) for rapid access to your most frequently dialed numbers. First make sure the DIALING MODE selector is set to TONE or PULSE (rotary) mode, since the number will be stored in the mode that is set at the time of programming.

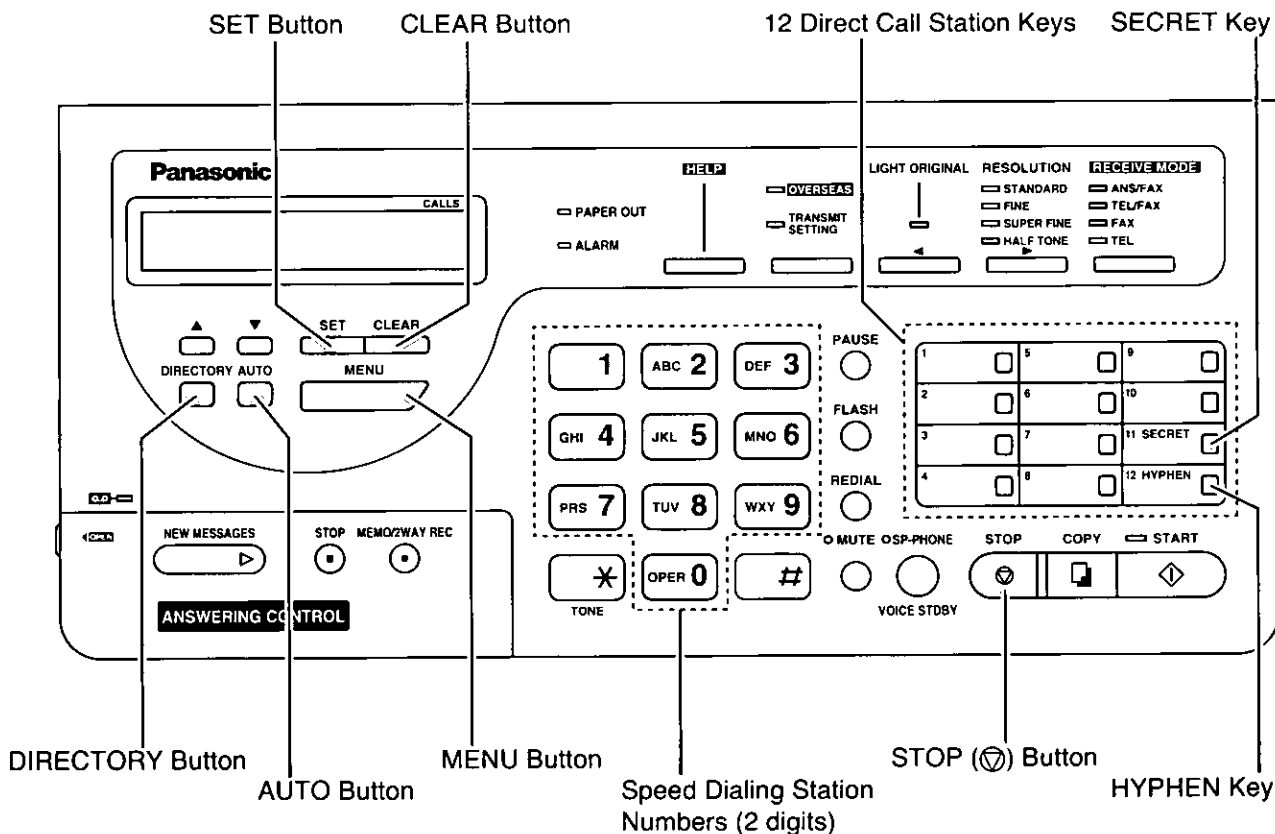

Filling in the directory card

1. Remove the cover using an instrument with a pointed end, like a pen, as shown below.
2. Remove the directory card.
3. Write in the names associated with the direct call station keys.
4. Re-install the directory card.

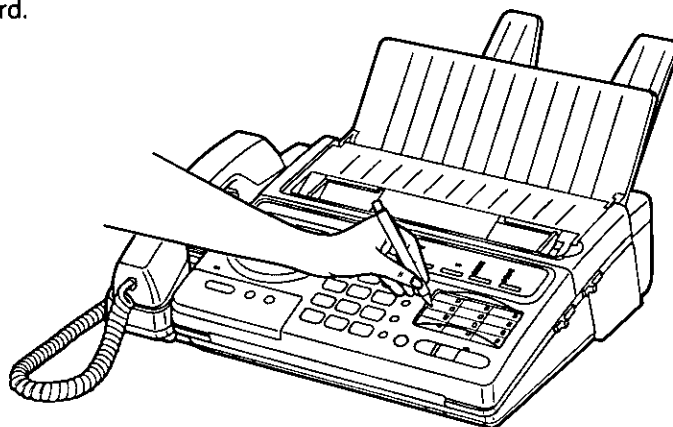

Storing phone numbers for one touch dialing

This unit is equipped with 12 direct call station keys including **SECRET** and **HYPHEN** keys, each of which can store a telephone number and a station name.

Each phone number can be programmed up to 30 digits long.

Each station name can be programmed up to 16 alphanumeric characters.

The stored names and telephone numbers are also automatically stored in the Electric Telephone Directory (see pages 4-9 and 4-10).

1

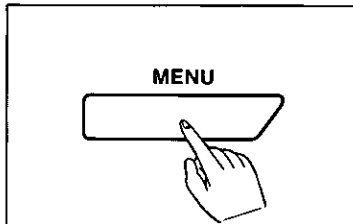

Press the **MENU** button until the following is shown.

PROGRAM[1.DATE 2.TEL
3.SYSTEM 4.REPORT]

2

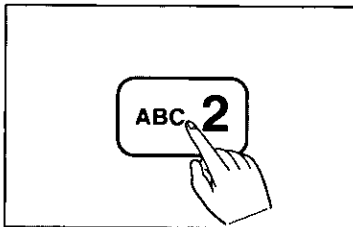

Press **2**.

SELECT AUTO OR
DIRECT CALL KEY

3

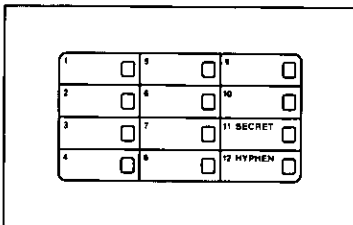

Press one of the direct call station keys where you want to store the phone number.

Example: The station number is 6.

ENTER PHONE NO.<S06>
=

4

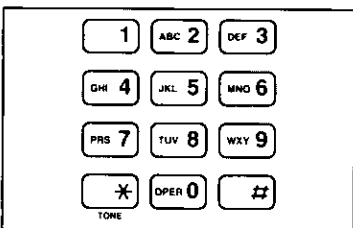

Enter the phone number by using the dial keypad.

Example: The phone number is 765-4321.

ENTER PHONE NO.<S06>
=7654321

If you want to insert a hyphen in the number, press the **HYPHEN** key during programming. **HYPHEN** is counted as 2 digits.

5

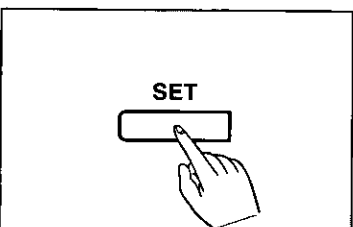

Press the **SET** button to store the program in memory.

ENTER NAME
=

(continued)

6

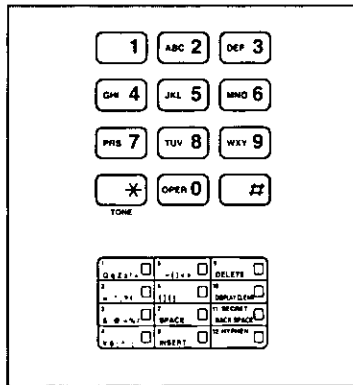

Enter the name associated with the direct call station by using the dial keypad and the direct call station keys as character keys, and the cursor keys.

7

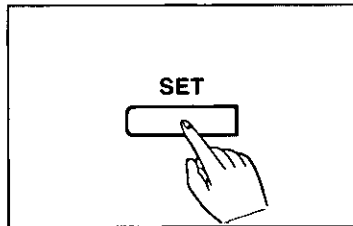

Press the **SET** button to store the program in memory.

SELECT AUTO OR
DIRECT CALL KEY

To program other phone numbers, repeat steps 3 to 7.

8

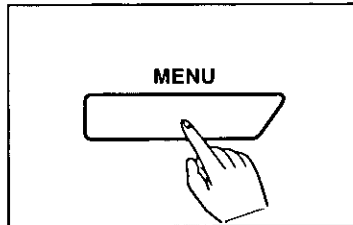

After programming all numbers, press the **MENU** button to end the operation.

The display shows the current time.

NOTES:

- To correct an error while programming, press the **CLEAR** button then make the correction.
- To cancel the programming halfway, press the **MENU** button.
- You can obtain a list of stored phone numbers (see pages 6-5 and 6-6).
- To enter the station name, use the character (station) keys and the cursor keys. For further details, see pages 2-8 and 2-9.

Storing phone numbers for speed dialing

The unit is equipped with 100 stations (00 through 99), each of which can store a phone number and a station name.

Each phone number can be programmed up to 30 digits long.

Each station name can be programmed up to 16 alphanumeric characters.

The stored names and telephone numbers are also automatically stored in the Electric Telephone Directory (see pages 4-9 and 4-10).

1

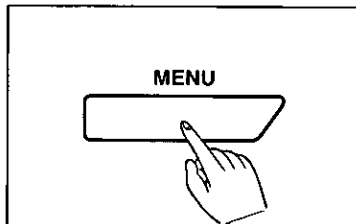

Press the **MENU** button until the following is shown.

PROGRAM[1.DATE 2.TEL
3.SYSTEM 4.REPORT]

2

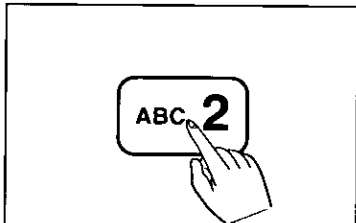

Press 2.

SELECT AUTO OR
DIRECT CALL KEY

3

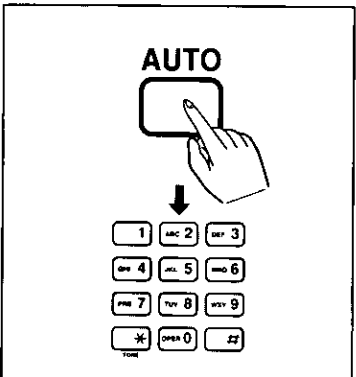

Press the **AUTO** button.

Enter the 2-digit number (00 through 99) by using the dial keypad.

Example: The station number is 00.

ENTER PHONE NO.<A00>
=

4

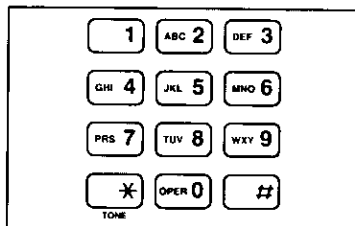

Enter the phone number by using the dial keypad.

Example: The phone number is 123-4567.

ENTER PHONE NO.<A00>
=1234567

If you want to insert a hyphen in the number, press the HYPHEN key during programming. HYPHEN is counted as 2 digits.

5

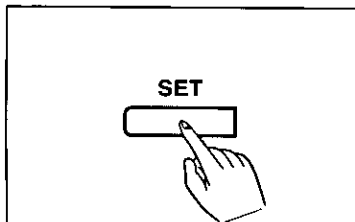

Press the **SET** button to store the program in memory.

ENTER NAME
=

(continued)

6

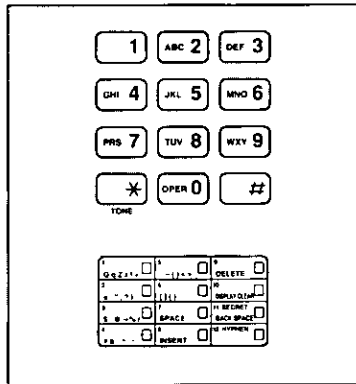

Enter the name associated with the speed dial station by using the dial keypad and the direct call station keys as character keys, and the cursor keys.

7

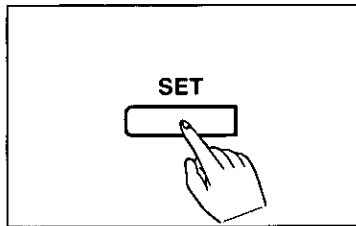

Press the **SET** button to store the program in memory.

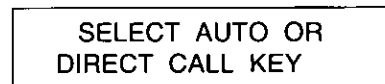

To program other phone numbers, repeat steps 3 to 7.

8

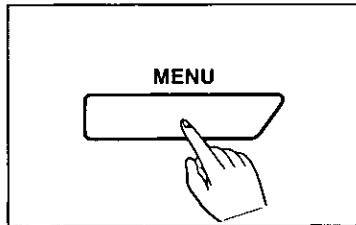

After programming all the numbers, press the **MENU** button to end the operation.

The display shows the current time.

NOTES:

- To correct an error while programming, press the **CLEAR** button then make the correction.
- To cancel the programming halfway, press the **MENU** button.
- You can obtain a list of the stored phone numbers (see pages 6-5 and 6-6).
- To enter the station name, use the character (station) keys and the cursor keys. For further details, see pages 2-8 and 2-9.

Storing secret phone numbers

This function is useful for keeping a whole phone number or a portion of a phone number secret. When you print out a list of the stored numbers, secret numbers will not be printed.

The stored names and telephone numbers are also automatically stored in the Electric Telephone Directory (see pages 4-9 and 4-10).

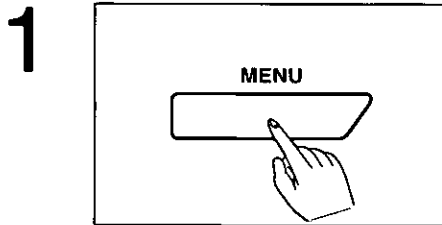

Press the **MENU** button until the following is shown.

```
PROGRAM[1.DATE 2.TEL
3.SYSTEM 4.REPORT]
```

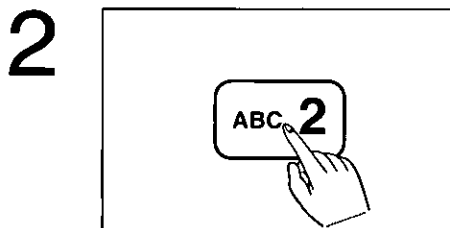

Press 2.

```
SELECT AUTO OR
DIRECT CALL KEY
```

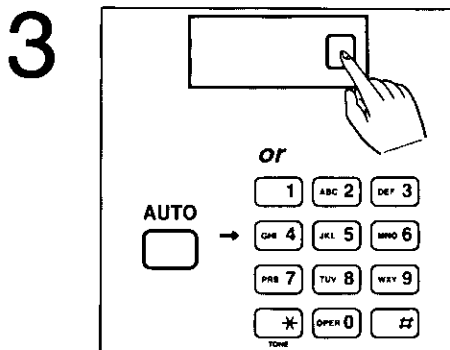

Press one of the direct call station keys.

or

Press the **AUTO** button.

Then enter the 2-digit number (00 through 99).

Example: The direct call station key 1 is pressed.

```
ENTER PHONE NO.<S01>
=
```

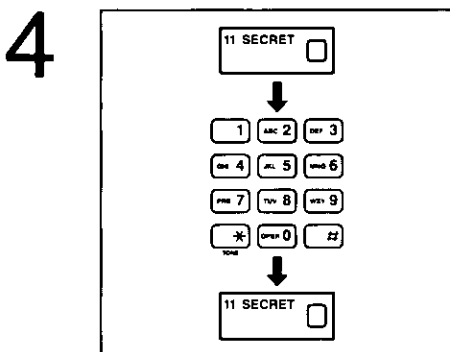

Press the **SECRET** key.

Then enter the phone number.

Then press the **SECRET** key again.

Example: The phone number is 123-4567.

Pressing the SECRET key once counts as 2 digits.

```
ENTER PHONE NO.<S01>
=[1234567]
```

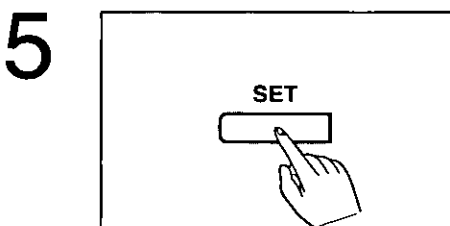

Press the **SET** button to store the program in memory.

```
ENTER NAME
=
```

(continued)

Intermediate Instructions

6

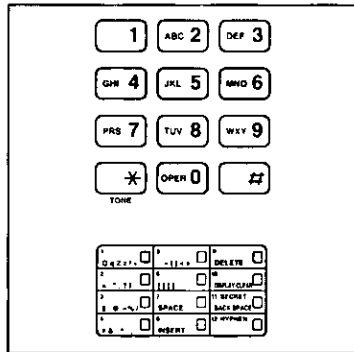

Enter the station name by using the dial keypad and the direct call station keys as character keys, and the cursor keys.

7

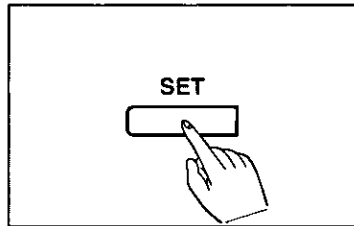

Press the **SET** button to store the program in memory.

SELECT AUTO OR
DIRECT CALL KEY

8

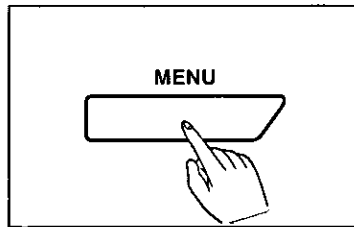

Press the **MENU** button to end the operation.

The display shows the current time.

NOTES:

- To correct an error while programming, press the **CLEAR** button then make the correction.
- To cancel the programming halfway, press the **MENU** button.

Electric Telephone Directory

The telephone numbers and their associated names stored in memory for automatic dialer are automatically registered in the Electric Telephone Directory in alphabetical order.

By using the Electric Telephone Directory feature, you can send a document or make a voice call by selecting the desired name from the display.

This is useful when you have forgotten the station number of the party you wish to call.

The way that the phone numbers are stored in the Electric Telephone Directory:

Stored data (example)

One touch dialing

ENTER PHONE NO. <S06>
=7654321
ENTER NAME
=ROBERT

ENTER PHONE NO. <S10>
=2345678
ENTER NAME
=ELIZABETH

Speed dialing

ENTER PHONE NO. <A00>
=1234567
ENTER NAME
=ANTHONY

ENTER PHONE NO. <A50>
=8765432
ENTER NAME
=JUDY

ENTER PHONE NO. <A72>
=5432109
ENTER NAME
=MARGARET

Secret phone number for
one touch dialing

ENTER PHONE NO. <S01>
=[9876543]
ENTER NAME
=MARY

Electric Telephone Directory

Stored names are registered in alphabetical order.

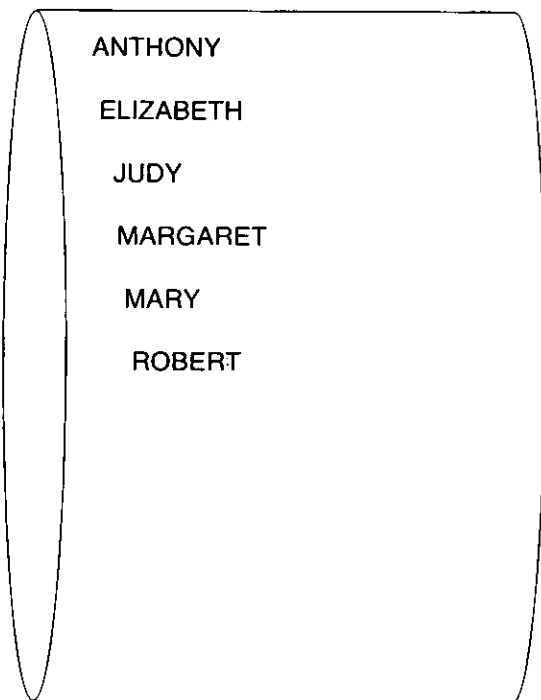

See pages 4-3 to 4-8, for storing phone numbers.

NOTES:

- Be sure to enter the names with the stored phone numbers before you use the Electric Telephone Directory.
- To send documents using the Electric Telephone Directory, see page 4-12.
- To make voice calls using the Electric Telephone Directory, see page 4-14.

How to use the Electric Telephone Directory

Example: You call "MARY" whose number is stored in memory associated with the direct call station 1.

1. Press the **DIRECTORY** button.

SELECT INDEX
 A-Z, 0-9, #

2. **To access directly to your desired index:**

Press **6** to select "M" using the dial keypad.

The display shows the first name with initial "M".

SELECT NAME <A72>
 =MARGARET

Then press the ▼ button repeatedly until "MARY" is displayed.

SELECT NAME <S01>
 =MARY

or

To look up your desired name in alphabetical order:

Press the ▼ button or the ▲ button repeatedly until the name you desire is displayed.

SELECT NAME <A00>
 =ANTHONY

SELECT NAME <S01>
 =MARY

3. Press the **SET** button.

SAT JAN 1 3:00PM 00
 <MARY>

4. The unit initiates dialing.

NOTE:

To select the desired index, use the dial keypad.

Index:	Index:	Index:
<div style="border: 1px solid black; border-radius: 10px; padding: 5px; display: inline-block; width: 40px; height: 40px; text-align: center; line-height: 40px;">1</div> ... 1	<div style="border: 1px solid black; border-radius: 10px; padding: 5px; display: inline-block; width: 40px; height: 40px; text-align: center; line-height: 40px;">ABC 2</div> ... ABC 2	<div style="border: 1px solid black; border-radius: 10px; padding: 5px; display: inline-block; width: 40px; height: 40px; text-align: center; line-height: 40px;">DEF 3</div> ... DEF 3
<div style="border: 1px solid black; border-radius: 10px; padding: 5px; display: inline-block; width: 40px; height: 40px; text-align: center; line-height: 40px;">GHI 4</div> ... GHI 4	<div style="border: 1px solid black; border-radius: 10px; padding: 5px; display: inline-block; width: 40px; height: 40px; text-align: center; line-height: 40px;">JKL 5</div> ... JKL 5	<div style="border: 1px solid black; border-radius: 10px; padding: 5px; display: inline-block; width: 40px; height: 40px; text-align: center; line-height: 40px;">MNO 6</div> ... MNO 6
<div style="border: 1px solid black; border-radius: 10px; padding: 5px; display: inline-block; width: 40px; height: 40px; text-align: center; line-height: 40px;">PRS 7</div> ... PQRS 7	<div style="border: 1px solid black; border-radius: 10px; padding: 5px; display: inline-block; width: 40px; height: 40px; text-align: center; line-height: 40px;">TUV 8</div> ... TUV 8	<div style="border: 1px solid black; border-radius: 10px; padding: 5px; display: inline-block; width: 40px; height: 40px; text-align: center; line-height: 40px;">WXY 9</div> ... WXYZ 9
<div style="border: 1px solid black; border-radius: 10px; padding: 5px; display: inline-block; width: 40px; height: 40px; text-align: center; line-height: 40px;">* <small>TO NE</small></div> ... (not assigned)	<div style="border: 1px solid black; border-radius: 10px; padding: 5px; display: inline-block; width: 40px; height: 40px; text-align: center; line-height: 40px;">OPER 0</div> ... 0	<div style="border: 1px solid black; border-radius: 10px; padding: 5px; display: inline-block; width: 40px; height: 40px; text-align: center; line-height: 40px;">#</div> ... Others

Example: To select the index "B", press **2** twice.

Transmitting Documents Using Automatic Dialer

You can transmit documents automatically using one touch dialing and speed dialing. Before using these features, make sure that the desired telephone numbers have been stored in memory. For storing phone numbers, see pages 4-3 to 4-8.

1

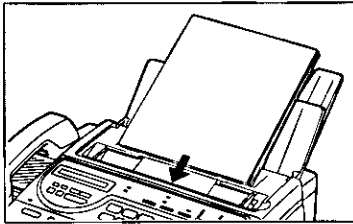

Insert the documents FACE DOWN.

The unit can accept up to 10 sheets of paper at a time.

2

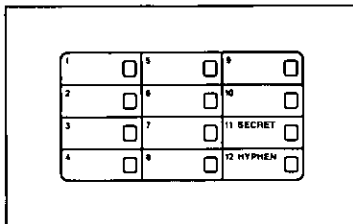

Using one touch dialing:

Press the desired direct call station key.

The unit dials and transmits the documents automatically.

or

or

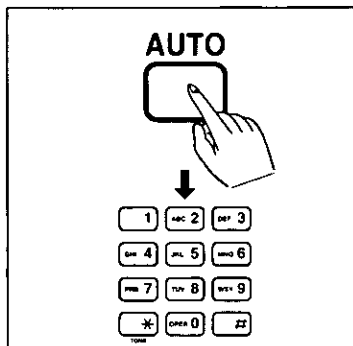

Using speed dialing:

Press the **AUTO** button.

Then enter the desired 2-digit number (00 through 99) by using the dial keypad.

The unit dials and transmits the documents automatically.

Automatic redialing feature:

If there is no answer or the line is busy, the unit will automatically redial the number up to 5 times. While waiting for the redialing, the display will show,

SAT JAN 1 3:00PM 00
WAITING TO REDIAL

To cancel automatic redialing, press the **STOP** (⏏) button.

NOTE:

To interrupt transmission, press the **STOP** (⏏) button until a beep sounds. Press the **STOP** (⏏) button again to eject the document.

Transmitting Documents Using Electric Telephone Directory

By using the Electric Telephone Directory feature (see pages 4-9 and 4-10), you can send documents by selecting the desired name from the display.

Make sure that the desired telephone numbers and their names have been stored in memory (see pages 4-3 to 4-8).

1

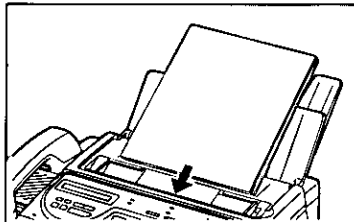

Insert the documents FACE DOWN.

The unit can accept up to 10 sheets of paper at a time.

2

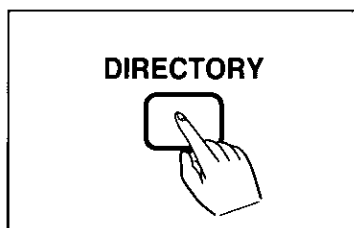

Press the **DIRECTORY** button.

SELECT INDEX
A-Z, 0-9, #

3

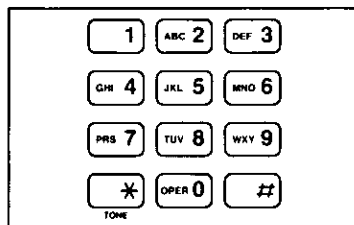

To access directly to your desired index:
Enter the desired index using the dial keypad (see page 4-10).

SELECT NAME <XXX>
=XXXXXXXXXX

The first name in the index is displayed.
or

or

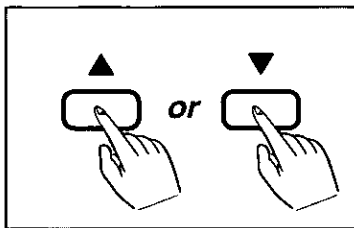

To look up the desired name from the top of the directory:

Press ▼ or ▲ until the desired name is shown.
Skip step 4.

4

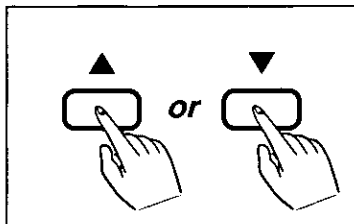

Press ▼ or ▲ until the desired name is displayed.

Use ▼ to advance the stored names, or ▲ to put back.

SELECT NAME <XXX>
=XXXXXXXXXX

5

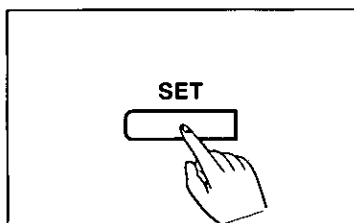

Press the **SET** button.

DIALING <XMT>
TO: XXXXXXXXX

The unit dials and transmits the documents automatically.

Making Voice Calls Using Automatic Dialer

The unit's memory allows you to use both one touch dialing (up to 12 phone numbers) and speed dialing (up to 100 phone numbers) for rapid access to your most frequently called numbers. Before using these features, make sure that the desired telephone numbers have been stored in memory (see pages 4-3 to 4-8).

1

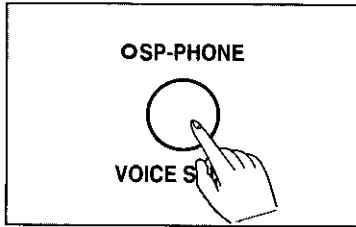

Press the **SP-PHONE** button or lift the handset.

2

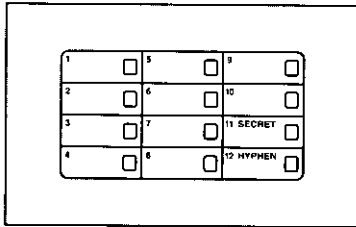

Using one touch dialing:
Press the desired direct call station key.

or

or

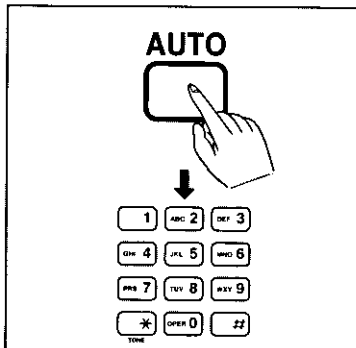

Using speed dialing:
Press the **AUTO** button.
Then press the desired station number (00 through 99) by using the dial keypad.

Making Voice Calls Using Electric Telephone Directory

By using the electric Telephone Directory feature (see pages 4-9 and 4-10), you can make voice calls by selecting the desired name from the display.

Make sure that the desired telephone numbers and their names have been stored in memory (see pages 4-3 to 4-8).

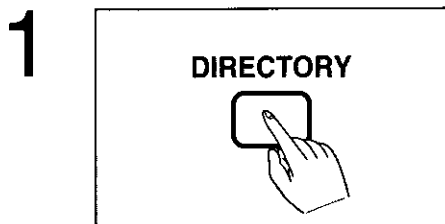

Press the **DIRECTORY** button.

SELECT INDEX
A-Z, 0-9, #

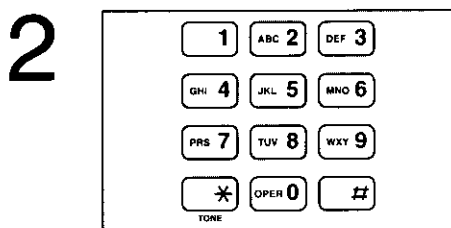

To access directly to your desired index:
Enter the desired index using the dial keypad (see page 4-10).

SELECT NAME <XXX>
=XXXXXXXXXX

The first name in the index is displayed.

or

or

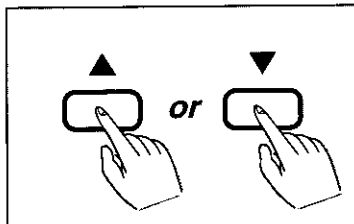

To look up the desired name from the top of the directory:

Press ▼ or ▲ until the desired name is shown.
Skip step 3.

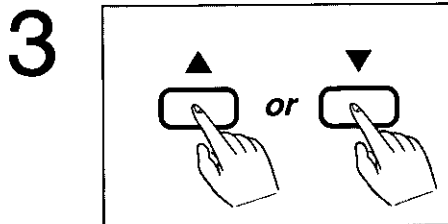

Press ▼ or ▲ until the desired name is displayed.
Use ▼ to advance alphabets, or ▲ to put back.

SELECT NAME <XXX>
=XXXXXXXXXX

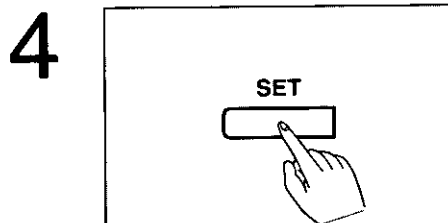

Press the **SET** button.

SAT JAN 1 3:00PM 00
<XXXXXXXXXX>

The unit initiates dialing.

Chapter 5

Advanced Instructions

Table of contents

<i>Facsimile and Copier</i>			
Delayed Transmission	5-2	Playing back newly recorded messages (Memory playback)	5-24
Network Communication	5-4	Playing back all messages	5-24
Using a passcode	5-4	Back space and skip forward	5-25
Programming the network passcode	5-6	Recording a marker message	5-25
Turning the TX passcode check on	5-7	Resetting the tape for future messages	5-26
Turning the RX passcode check on	5-8	Answer back	5-27
Junk Mail Prohibitor	5-9	Skipping the greeting message for incoming message recording mode	5-27
Turning on the junk mail prohibitor	5-9	Re-recording a greeting message	5-28
Transmitting documents to your unit with a special code	5-11	Setting the Message Alert	5-29
Remote Fax Receiving Using an Extension Phone	5-12	<i>Telephone</i>	
Using an extension phone	5-12	Voice Contact	5-30
Changing a remote fax activation code	5-13	Initiating voice contact	5-30
Receiving with Distinctive Ring Service	5-14	Receiving a request for voice contact	5-30
Programming the unit with distinctive ringing pattern	5-15	TONE, FLASH and PAUSE Button Usage	5-31
Using OVERSEAS/TRANSMIT SETTING Button	5-16	TONE button (Temporary tone dialing)	5-31
Using overseas transmission mode	5-16	FLASH button	5-31
Setting a total page number on your fax document	5-16	PAUSE button	5-32
Setting the Logo Print Position	5-18	Combination dialing	5-32
Setting the Paper Save Function	5-19	<i>Other Features</i>	
Extension Copy	5-21	Setting Day/Night Mode	5-33
<i>Answering Device</i>		Setting Silent Fax Recognition Ring	5-35
Operating the Answering Device from a Remote Phone	5-23	Resetting the Setup Features	5-36
Summary of remote control functions	5-23		

When the display shows any error message, see page 7-2 for corrective measures.

Delayed Transmission

Using a built-in clock, this unit can send documents automatically at a specific time. This allows you to take advantage of low-cost calling hours given by some telephone companies. The delayed transmission can be reserved to take place within 24 hours in advance.

1

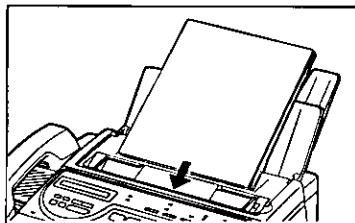

Insert the documents **FACE DOWN**.

The unit can accept up to 10 sheets of paper at a time.

2

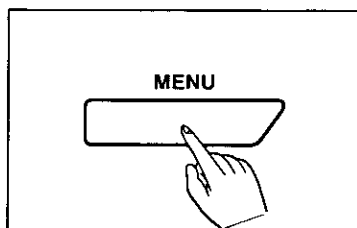

Press the **MENU** button until the following is shown.

DELAYED XMT
=OFF [1.ON 2.OFF]

3

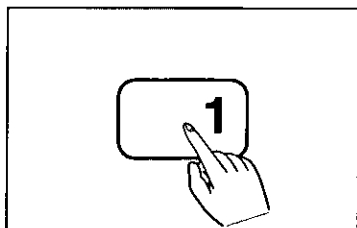

Press **1** to activate this feature.

DELAYED XMT
=ON [1.ON 2.OFF]

4

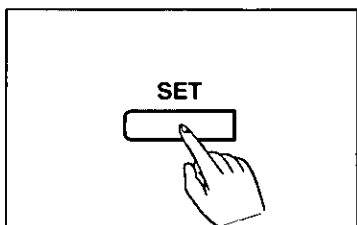

Press the **SET** button.

ENTER PHONE NUMBER
=

5

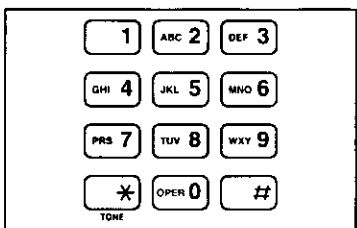

Enter the desired phone number using the direct call station key, the speed dial station or a full number.

Example: The direct call station 6 is dialed.

ENTER PHONE NUMBER
=<S06>

6

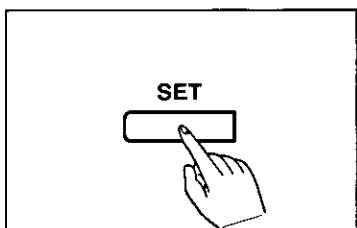

Press the **SET** button.

SET START TIME
12:00AM [*=AM #=PM]

7

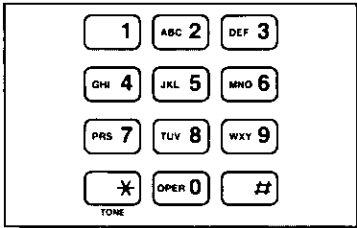

Enter the time at which you want the unit to start transmission.

Example: If the starting time is 11:00PM, press 1100, then press #.

SET START TIME
11:00PM [*=AM #=PM]

8

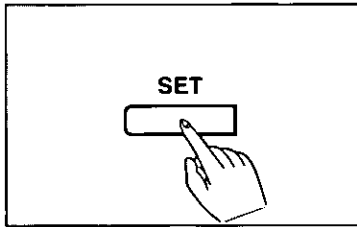

Press the **SET** button to store the program in memory.

SAT JAN 1 3:30PM 00
XMT AT 11:00PM

The delayed transmission has been set.

To cancel the delayed transmission:

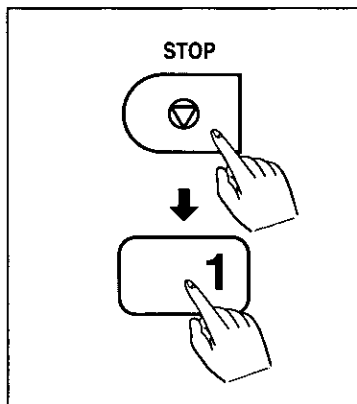

Press the **STOP** (⊘) button.

CANCEL DELAYED
XMT? [1.YES 2.NO]

Then press 1.

NOTES:

- You can receive, transmit and copy documents while the delayed transmission is set. To copy or transmit documents after setting delayed transmission, remove documents from the tray and replace them when you have finished.
- If there is no answer or the line is busy during the delayed operation, the unit will automatically redial the number up to 5 times.
- Only one delayed transmission can be set. If you set another delayed transmission, the previous one is overridden.
- You can use the Electric Telephone Directory (see pages 4-9 and 4-10) when entering the phone number in step 5.

Network Communication

The network communication feature with network passcode eliminates fax transmission to unauthorized parties, and helps to prevent reception from an unauthorized station.

This feature is effective to prevent "Junk mail" faxes since only those units with the same passcode can transmit to your unit.

When the network communication feature is used, the identical network passcode of 4 digits must be programmed on both sides of the line. The unit checks the passcode before transmitting or receiving a document.

The unit provides two types of passcode check modes. They are TX (transmission) passcode check mode and RX (reception) passcode check mode.

■ **TX Passcode Check:**

Use this feature to restrict document transmission. If the passcode sent from the other Panasonic compatible machines does not match with the one programmed in your unit, transmission does not take place (see page 5-7 for TX passcode check setting).

■ **RX Passcode Check:**

Use this feature to restrict document reception. If the passcode sent from the other Panasonic compatible machines does not match with the one programmed in your unit, reception does not take place (see page 5-8 for RX passcode check setting).

NOTES:

- These features are effective only between Panasonic compatible machines that have the same passcode.

Using a passcode

Before communication begins, check that your passcode and the other station's passcode are identical.

■ **When you want to transmit a document to a designated station only:**

Set TX PASSCODE CHECK to ON.

Function	Your unit	Other Panasonic compatible machine
TX PASSCODE CHECK	ON	ON/OFF
RX PASSCODE CHECK	OFF	ON/OFF

Your unit transmits a document only when the correct passcode has been received.

■ **When you want to receive a document from a designated station only:**

Set RX PASSCODE CHECK to ON.

Function	Your unit	Other Panasonic compatible machine
TX PASSCODE CHECK	OFF	ON/OFF
RX PASSCODE CHECK	ON	ON/OFF

Your unit receives a document only when the correct passcode has been received.

■ **When you want to send a document to and receive a document from a designated station (TX passcode check and RX passcode check mode):**

Set both TX PASSCODE CHECK and RX PASSCODE CHECK to ON.

Function	Your unit	Other Panasonic compatible machine
TX PASSCODE CHECK	ON	ON/OFF
RX PASSCODE CHECK	ON	ON/OFF

Your unit transmits and receives a document only when the correct passcode has been received.

■ **When you want to have facsimile communications within a designated group of people:**

All the people in the group must set both TX PASSCODE CHECK and RX PASSCODE CHECK to ON.

Function	Your unit	Other Panasonic compatible machine
TX PASSCODE CHECK	ON	ON
RX PASSCODE CHECK	ON	ON

Only units that share identical passcodes can transmit and receive documents with each other.

Programming the network passcode

To activate this feature, the identical network passcode must be preprogrammed both on your unit and the other Panasonic compatible machine(s).
The network passcode may be any 4-digit number except "0000".

1

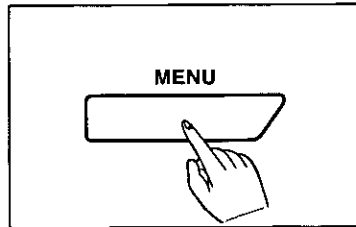

Press the **MENU** button until the following is shown.

```
PROGRAM[1.DATE 2.TEL
3.SYSTEM 4.REPORT]
```

2

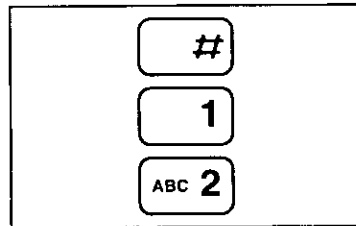

Press #, then press 12.

```
NETWORK PASSCODE
=0000
```

3

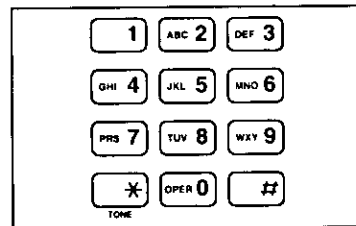

Enter the desired 4-digit passcode (choose from 0001-9999).

4

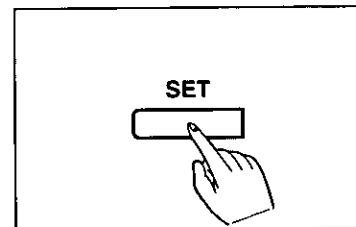

Press the **SET** button to store the program in memory.

```
PROGRAM[1.DATE 2.TEL
3.SYSTEM 4.REPORT]
```

5

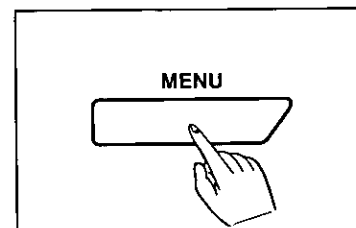

Press the **MENU** button to end the operation.

The display shows the current time.

NOTE:

- The network passcode is preset to "0000", which does not activate the network communication feature.
- If you make a mistake in step 3, use the cursor key (◀ or ▶) to move the cursor to the incorrect number, then make the correction.

Turning the TX passcode check on

1

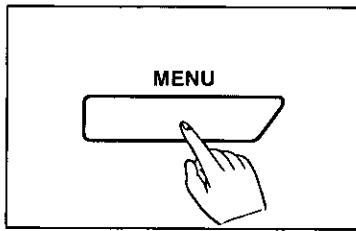

Press the **MENU** button until the following is shown.

PROGRAM[1.DATE 2.TEL
3.SYSTEM 4.REPORT]

2

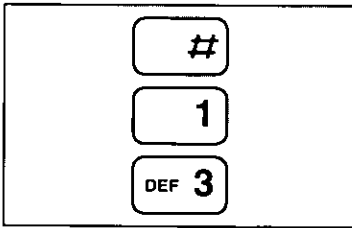

Press #, then press **13**.

TX PASSCODE CHECK
=OFF [1.ON 2.OFF]

3

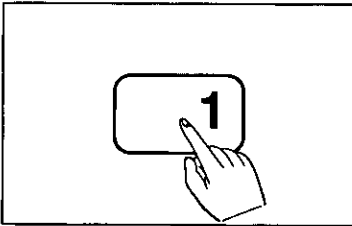

Press **1** to activate this feature.

TX PASSCODE CHECK
=ON [1.ON 2.OFF]

4

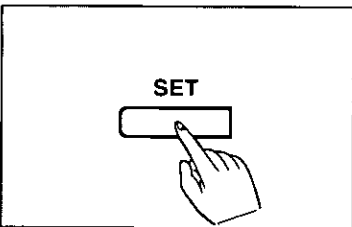

Press the **SET** button to store your selection in memory.

PROGRAM[1.DATE 2.TEL
3.SYSTEM 4.REPORT]

5

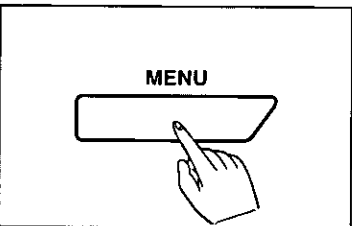

Press the **MENU** button to end the operation.

SAT JAN 1 3:00PM 00
TX PASSCODE CHECK ON

NOTE:

If the network passcode is set to "0000", this feature does not work properly.

Turning the RX passcode check on

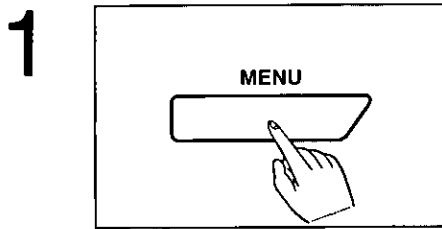

Press the **MENU** button until the following is shown.

PROGRAM[1.DATE 2.TEL
3.SYSTEM 4.REPORT]

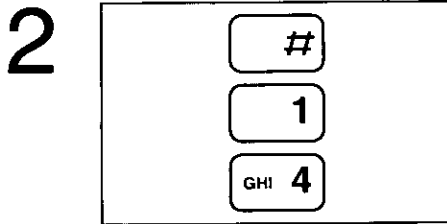

Press #, then press **14**.

RX PASSCODE CHECK
=OFF [1.ON 2.OFF]

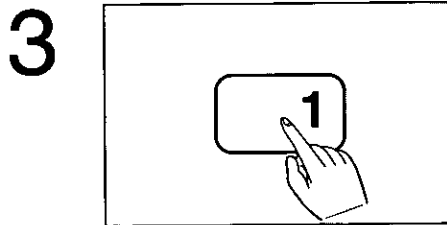

Press **1** to activate this feature.

RX PASSCODE CHECK
=ON [1.ON 2.OFF]

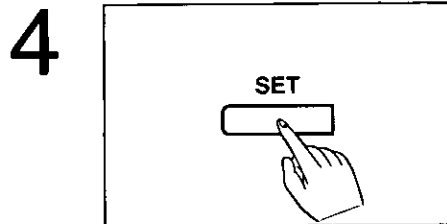

Press the **SET** button to store your selection in memory.

PROGRAM[1.DATE 2.TEL
3.SYSTEM 4.REPORT]

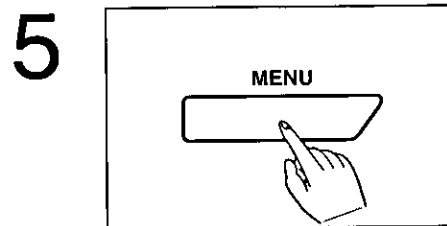

Press the **MENU** button to end the operation.

SAT JAN 1 3:00PM 00
RX PASSCODE CHECK ON

NOTE:

If the network passcode is set to "0000", this feature does not work properly.

Junk Mail Prohibitor

The feature allows the unit to receive fax document only from the stations whose phone numbers are registered into memory for one touch dialing and speed dialing, or the stations with a special code (JUNK MAIL PROHIBITOR ID).

The feature is effective to prevent receptions from unauthorized stations.

NOTE:

- To activate the feature, set the unit in the *ANS/FAX*, *TEL/FAX* or *FAX* mode and let the unit receive fax documents automatically.
- When manual reception is used, all the fax documents transmitted will be received.
- The unit will not be able to receive fax documents automatically from the machines registered for one touch dialing and speed dialing if the transmitting machines are not programmed with their telephone numbers.
- When the ring pattern detection feature (see pages 5-14 and 5-15) is used, the transmission using the JUNK MAIL PROHIBITOR ID will not be available.

Turning on the junk mail prohibitor

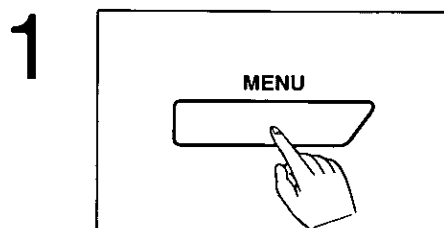

Press the **MENU** button until the following is shown.

PROGRAM[1.DATE 2.TEL
3.SYSTEM 4.REPORT]

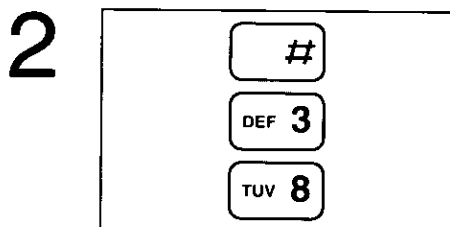

Press #, then press **38**.

JUNKMAIL PROHIBITOR
=OFF [1.ON 2.OFF]

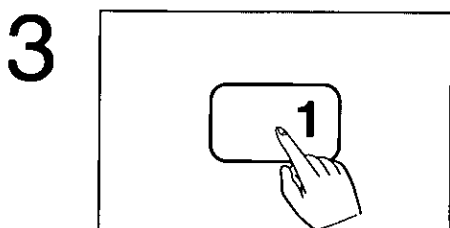

Press **1** to activate the feature.

JUNKMAIL PROHIBITOR
=ON [1.ON 2.OFF]

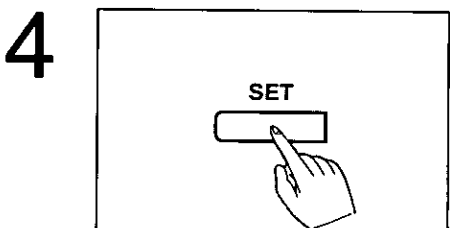

Press the **SET** button.

JUNKMAIL PROHIBITOR
ID=22

(continued)

5

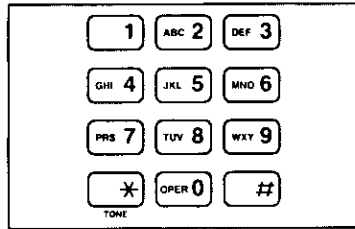

Enter the desired 2-digit JUNK MAIL PROHIBITOR ID (choose from 11–99).

0, # and * cannot be used.

6

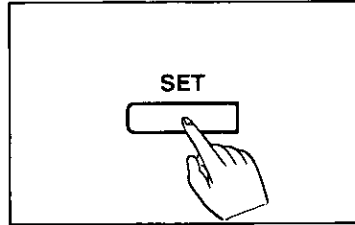

Press the **SET** button to store the program into memory.

PROGRAM[1.DATE 2.TEL
3.SYSTEM 4.REPORT]

7

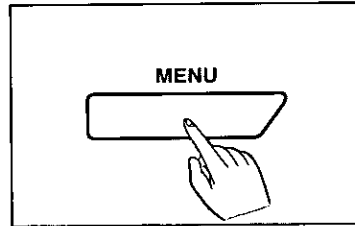

Press the **MENU** button to end the operation.

SAT JAN 1 3:00PM 00
JUNKMAIL PROHIBIT ON

NOTE:

The JUNK MAIL PROHIBITOR ID must be different from the first two digits of the REMOTE ANS ID (see page 2-16). For example, if the REMOTE ANS ID is set to “321”, do not use “32” as a JUNK MAIL PROHIBITOR ID.

Transmitting documents to your unit with a special code

Transmission with JUNK MAIL PROHIBITOR ID is activated when the unit is in the *ANS/FAX* or *TEL/FAX* mode.

Issue the JUNK MAIL PROHIBITOR ID to callers with priority status.

Instructions for caller:

1

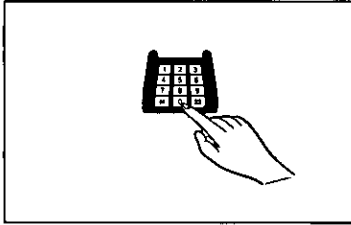

Your caller may call your unit.

2



If the unit is in the *ANS/FAX* mode:

They may enter the JUNK MAIL PROHIBITOR ID while the greeting message is being played or after they record their incoming messages.

If the unit is in the *TEL/FAX* mode:

They may enter the JUNK MAIL PROHIBITOR ID while the different ring back tone is heard.

3

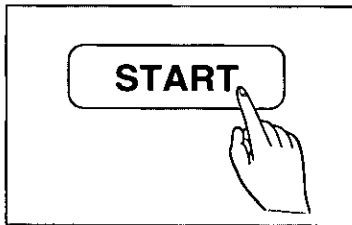

They may press their start or transmit button to initiate the fax transmission.

Remote Fax Receiving Using an Extension Phone

If you connect an extension to the same line to which your facsimile unit is connected, it is possible to receive a fax document into your facsimile unit by using the extension telephone near you.

This saves you the trouble of going to the facsimile unit and pressing the START button.

NOTES:

- This feature is only effective when you receive a call.
- To activate this feature, use a touch tone telephone as an extension phone.

Using an extension phone

1

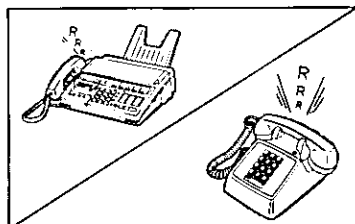

A call comes in.

2



Lift the handset of the extension phone.

3

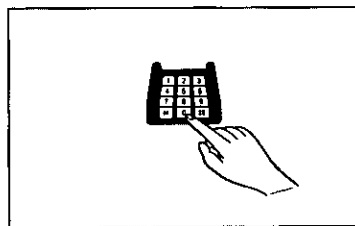

If a fax tone is heard, or the other party wishes to send you a fax, press * and * on the extension phone.

Then replace the handset on the cradle.

4

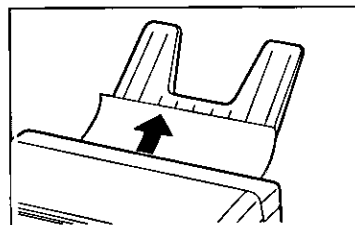

The unit switches to the fax mode, then receives a document.

NOTE:

Two *s (Remote Fax Activation Code) can be changed to another 2 to 4-digit number (see page 5-13).

Changing a remote fax activation code

Your code can be from 2 to 4 digits long. The numbers 0 through 9 and characters # and * may be used. (e.g. **, 123, 123#)

1

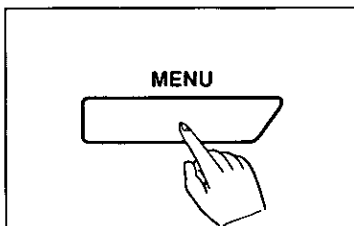

Press the **MENU** button until the following is shown.

PROGRAM[1.DATE 2.TEL
3.SYSTEM 4.REPORT]

2

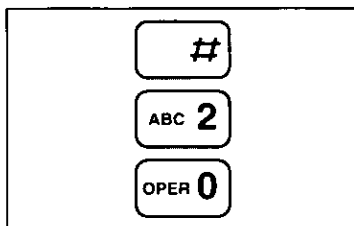

Press #, then press 20.

REMOTE FAX ACT.
CODE=**

3

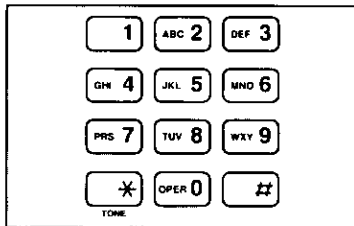

Enter the new code number using the dial keypad.

4

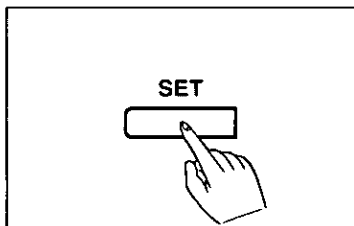

Press the **SET** button to store your program in memory.

PROGRAM[1.DATE 2.TEL
3.SYSTEM 4.REPORT]

5

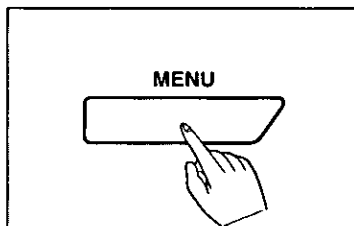

Press the **MENU** button to end the operation.

The display shows the current time.

NOTE:

If the remote fax activation code is set to "0000", the unit does not work properly.

Receiving with Distinctive Ring Service

The unit has been equipped with a Ring Pattern Detection feature, which allows you to have more effective use of the distinctive ring service provided by the telephone company.

The distinctive ring service gives you up to 3 phone numbers on your single telephone line, each with a different ringing pattern. You may use one of the phone numbers as a facsimile telephone number. With the ring pattern detection feature, the unit will detect its own distinctive ringing pattern and automatically activate the fax function to receive documents.

If other calls come in, the unit will answer in the pre-selected receiving mode by the RECEIVE MODE button.

■ The table below shows how the unit will answer when receiving calls.

Receiving call	Receiving mode of the unit			
	ANS/FAX	TEL/FAX	FAX	TEL
A call with distinctive ring pattern	The unit will activate the fax function.	The unit will activate the fax function.	The unit will activate the fax function.	The unit will ring until you pick up. If you do not answer the call by 15 rings, the unit will automatically switch to the ANS/FAX mode.
Other call	The unit will activate as an answering device and/or facsimile.	The unit will ring until you pick up.		

NOTE:

- In *ANS/FAX* and *FAX* modes, the *FAX RING COUNT* setting determines the number of distinctive rings before transmissions are received.
- In *TEL/FAX* mode, a call with distinctive ring pattern will be received without ringing. But other extension phones, if connected on the same line, will ring 1 to 4 times depending on the setting of the *FAX RING COUNT* before the unit initiates fax reception.

Programming the unit with distinctive ringing pattern

To activate the feature, you need to program the ringing pattern of the phone number to be used as a facsimile number.

Ringing pattern that can be programmed.

A: Standard ring

B: Double ring

C: Triple ring (Short-long-short)

D: Other triple ring

OFF: Turning off the ring pattern detection feature

1

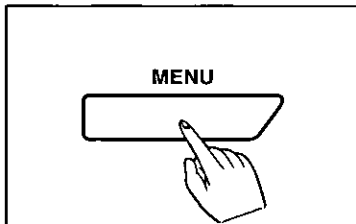

Press the **MENU** button until the following is shown.

PROGRAM[1.DATE 2.TEL
3.SYSTEM 4.REPORT]

2

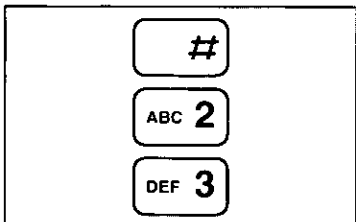

Press #, then press **23**.

RING_DETECT=OFF[1.A
2.B 3.C 4.D 5.OFF]

3

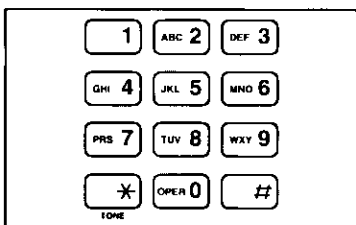

Enter the number you wish to set.

Example: To set the double ring, enter 2.

4

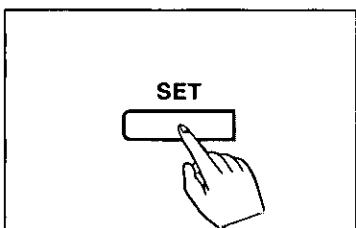

Press the **SET** button to store your selection into memory.

PROGRAM[1.DATE 2.TEL
3.SYSTEM 4.REPORT]

5

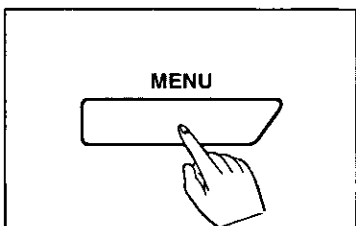

Press the **MENU** button to end the operation.

The display shows the current time.

Using the OVERSEAS/TRANSMIT SETTING Button

The OVERSEAS/TRANSMIT SETTING button allows for the setting of the overseas transmission mode, and for the printing of the total page number on the fax document sent by the unit.

Using overseas transmission mode

When transmitting documents overseas, there will be some problems that may occur in international communication, such as bad line connections. If this occurs, use the overseas transmission mode.

You can set this mode by pressing the OVERSEAS/TRANSMIT SETTING button.

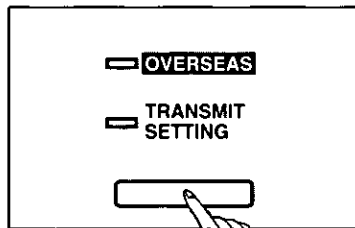

Press the **OVERSEAS/TRANSMIT SETTING** button before transmission.

The OVERSEAS indicator will light. Then make the transmission.

NOTE:

- After the transmission, this mode is not canceled automatically.
- When the overseas transmission mode is set, the time required to make the transmission will be longer than normal.

Setting a total page number on your fax document

The total page number will be printed at the top of each transmitted page, along with the number of page.

Sample page sent by your unit:

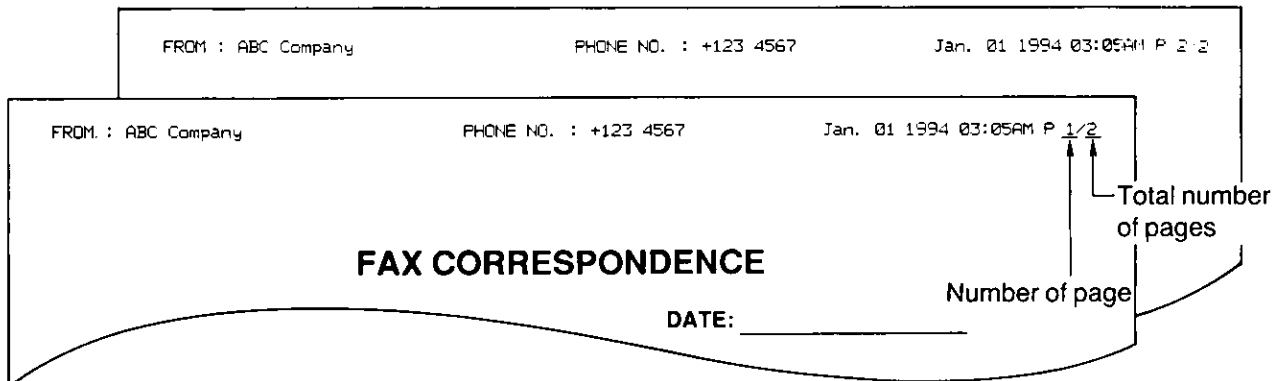

To set the total page number, follow the steps below before beginning transmission.

HELPFUL HINT:

If you lose your instructions while operating, press the HELP button. The unit will print information on how to operate.

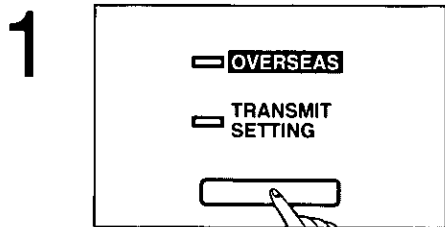

Press the **OVERSEAS/TRANSMIT SETTING** button until the TRANSMIT SETTING indicator lights.

SET NUMBER OF PAGES
TOTAL=0

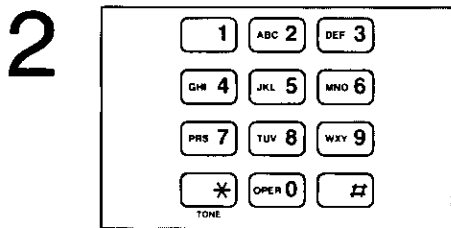

Enter the total number of pages transmitted (1 to 99).

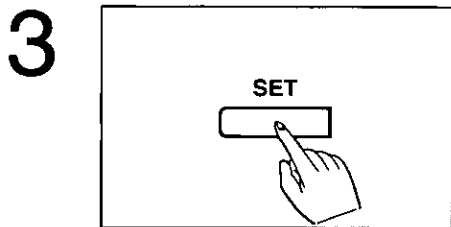

Press the **SET** button.

The indicator light goes off.



Start transmission.

You may use manual transmission, automatic transmission or delayed transmission. After the transmission, the feature is automatically turned off.

Setting the Logo Print Position

Your logo, your telephone number, date, time and page number will be printed on the transmitted document from your unit in the following condition.

OUT: Outside of the transmitted document's paper size (default).

IN: Inside of the transmitted document's paper size.

OFF: Not printed.

To change the logo position, proceed as follows:

1

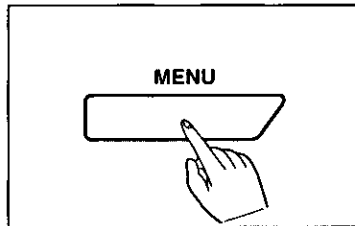

Press the **MENU** button until the following is shown.

PROGRAM[1.DATE 2.TEL
3.SYSTEM 4.REPORT]

2

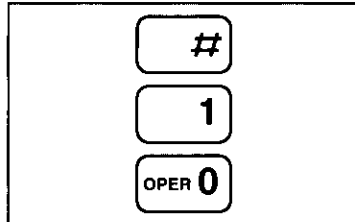

Press #, then press **10**.

LOGO POSITION=OUT
[1.OUT 2.IN 3.OFF]

3

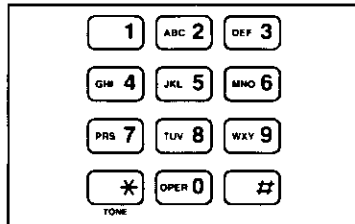

Press the number of the selection you desire.

Setting selections are:

- 1: OUT
- 2: IN
- 3: OFF

4

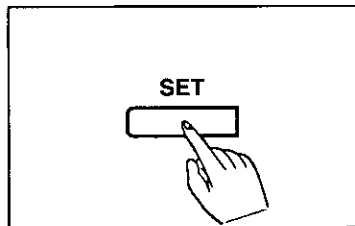

Press the **SET** button to store your selection in memory.

PROGRAM[1.DATE 2.TEL
3.SYSTEM 4.REPORT]

5

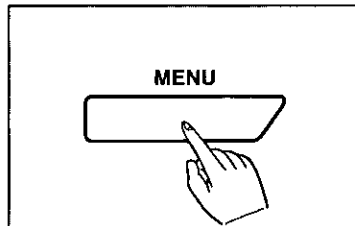

Press the **MENU** button to end the operation.

The display shows the current time.

Setting the Paper Save Function

When this function is on, the unit will reduce the data sent by the other party to a half in length when printing out. This function also works in making a copy.

Original document

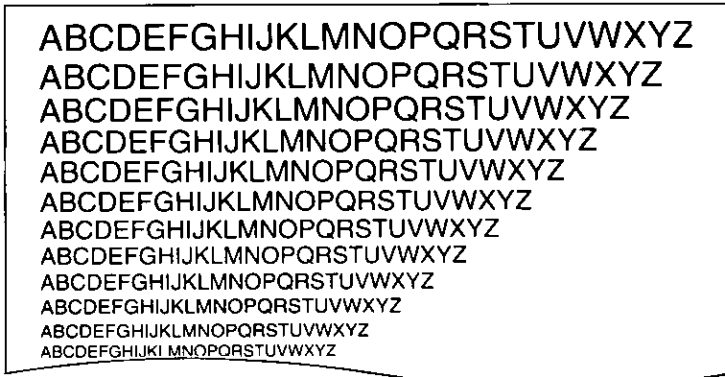

Received document

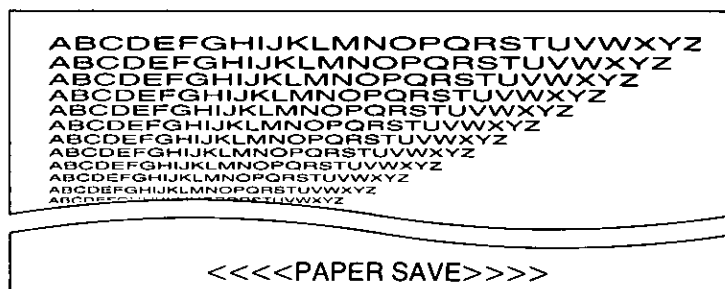

NOTE:

This feature does not work when the other party send documents in fine resolution or other nonstandard resolution, or when you make a copy using the FINE, SUPER FINE or HALF TONE resolution.

To set the Paper Save function:

1

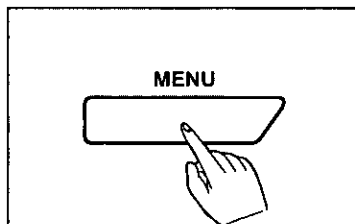

Press the **MENU** button until the following is shown.

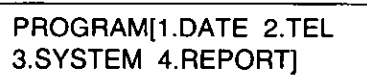

2

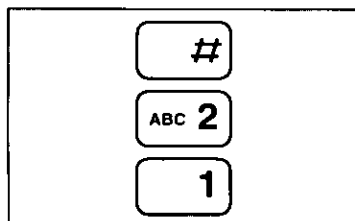

Press #, then press 21.

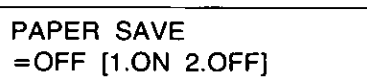

(continued)

3

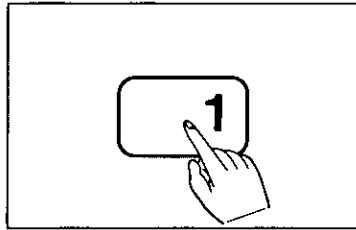

Press 1 to activate this function.

PAPER SAVE
=ON [1.ON 2.OFF]

4

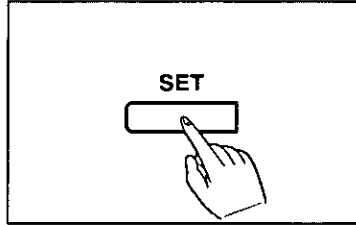

Press the **SET** button to store your selection in memory.

PROGRAM[1.DATE 2.TEL
3.SYSTEM 4.REPORT]

5

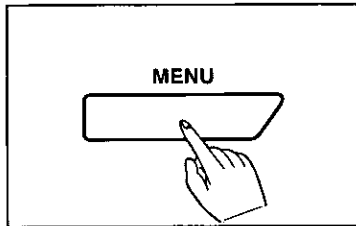

Press the **MENU** button to end the operation.

SAT JAN 1 3:00PM 00
PAPER SAVE ON

Extension Copy

When this feature is on, the unit will copy a document twice in length.
When it is hard to read a document sent by the other unit since your unit is in the Paper Save function (see page 5-19) or for other reasons, we recommend that you use this feature.

Original document

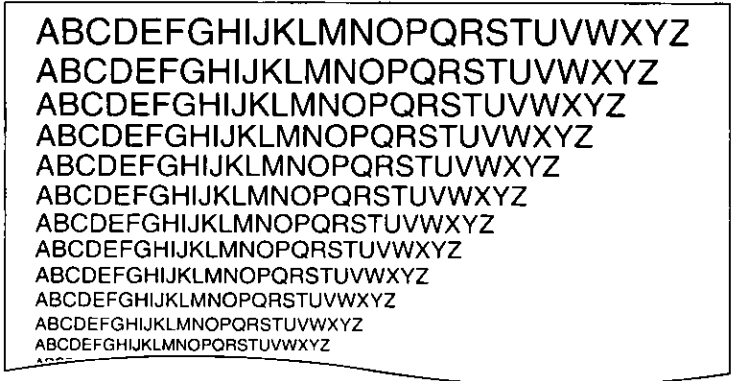

Extended copy



To make an extension copy:

1

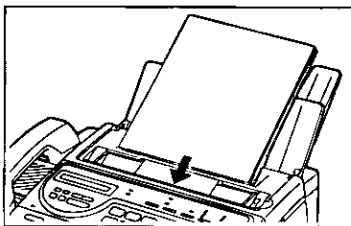

Insert the documents **FACE DOWN**.

2

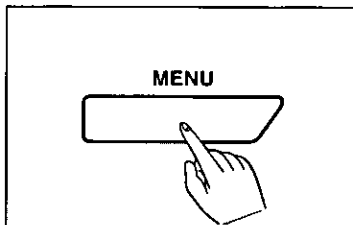

Press the **MENU** button until the following is shown.

PROGRAM[1.DATE 2.TEL
3.SYSTEM 4.REPORT]

(continued)

3

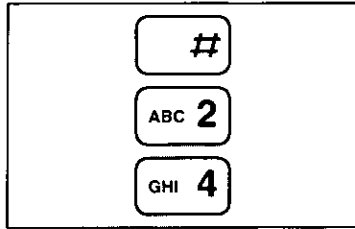

Press #, then press 24.

EXTENSION COPY
PRESS COPY KEY

4

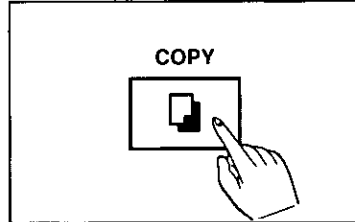

Press the **COPY** button.

The unit starts making a copy.

EXTENSION COPY
COPYING DOCUMENT

When finished, the display shows the following.

PROGRAM[1.DATE 2.TEL
3.SYSTEM 4.REPORT]

5

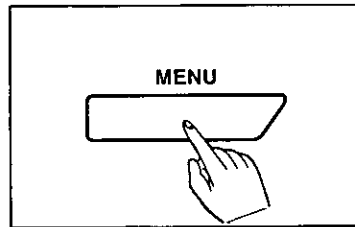

Press the **MENU** button to end the operation.

The display shows the current time.

NOTES:

- This feature works even if the Paper Save function is on.
- To cancel an extension copy before pressing the COPY button, press the **MENU** button or the **STOP** (⏏) button twice. To stop copying, press the **STOP** (⏏) button.
- When copying documents printed on thermal recording paper, feed them into the unit one by one or they may jam.

Operating the Answering Device from a Remote Phone

While you are out, you can listen to any recorded incoming messages or re-record your greeting message using a touch tone telephone.

The following features are available on this unit:

- Playing back newly recorded messages
- Playing back all the recorded messages
- Back space and skip forward
- Recording a marker message
- Resetting the tape for future messages
- Answer back
- Re-recording the greeting message
- Skipping the greeting message for incoming message recording mode

Before using these features, you must program your unique remote code (REMOTE ANS ID) that lets you access the answering device of your unit.

The REMOTE ANS ID is preset to "111" as a default.

If you wish to change the code, see page 2-16.

Summary of remote control functions

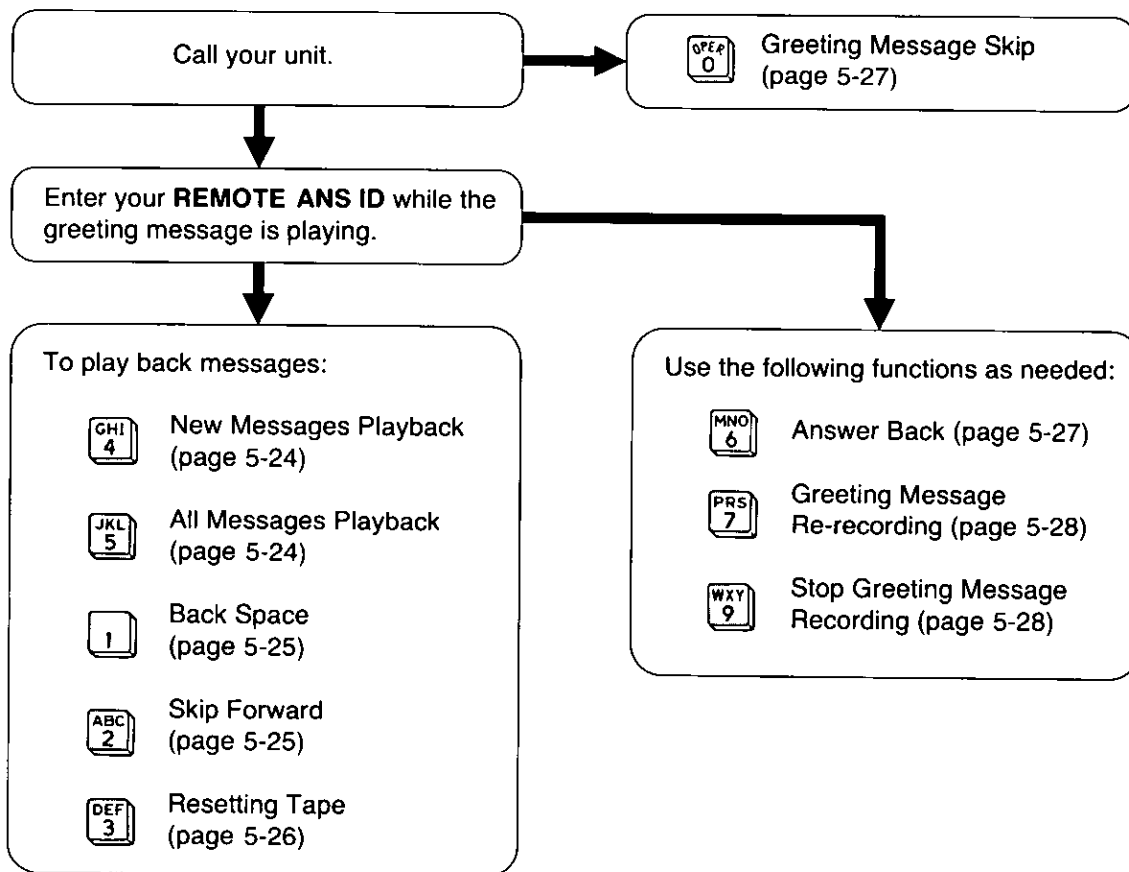

NOTE:

For your convenience, a quick reference card for remote operation is attached in these operating instructions (see pages 8-15 and 8-16).

Playing back newly recorded messages (Memory playback)

It is possible to skip over the recorded messages you have already heard and to play back only new messages.

1

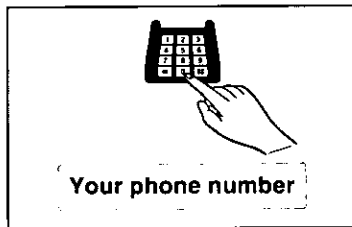

Call your unit.

2

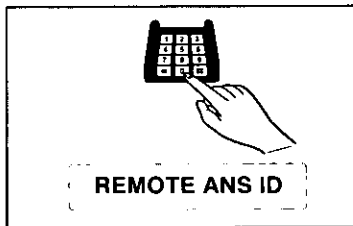

Dial your **REMOTE ANS ID** while the greeting message is playing.

A long beep and a short beep(s) will sound. Short beep(s) indicate(s) the number of recorded messages up to 8 times. Even if 9 or more calls are recorded, a short beep sounds 8 times.

3

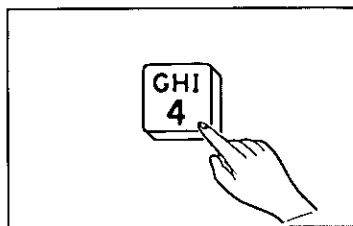

Press **4** immediately after hearing the beeps that indicate the number of recorded messages.

The unit plays back the new messages.

NOTE:

Even during the playback of previously heard messages, you can skip them by pressing **4**.

Playing back all messages

You can listen to all the recorded messages from the beginning of the tape.

1

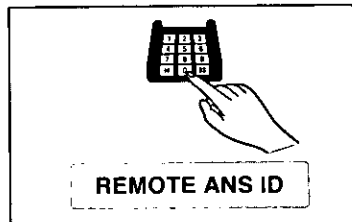

Call your unit then dial your **REMOTE ANS ID** while the greeting message is playing.

2

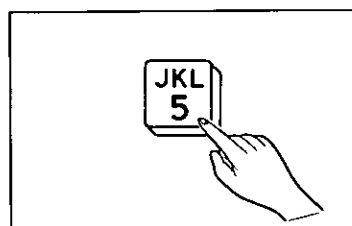

Press **5** within 4 seconds after the short beeps.

The unit will rewind the tape and start to play back all messages.

At the end of the last message, 3 beeps will sound. After hanging up, all the recorded messages are saved and the unit is ready to record further messages.

NOTE:

Even if you do not press 5 in step 2, playback of all messages starts automatically.

Back space and skip forward

While listening to the recorded messages, you can rewind or advance the tape.

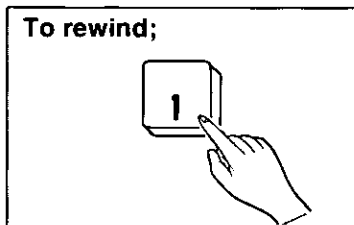

To rewind, press 1.

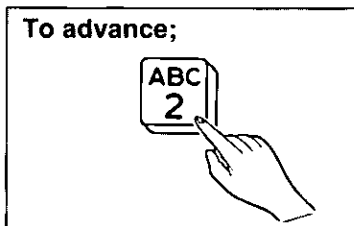

To advance, press 2.

NOTE:

The maximum length of a message that can be rewound or advanced by one press is approximately 15 seconds. You may have to press 1 or 2 several times to rewind or advance the tape to the desired position.

Recording a marker message

After playing back the recorded messages, you can leave an additional message during the same call.

When playback is finished, wait for 3 beeps indicating the end of the last message. Wait about 10 seconds for another 2 beeps indicating that the tape is ready for recording.

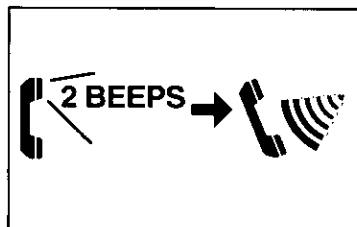
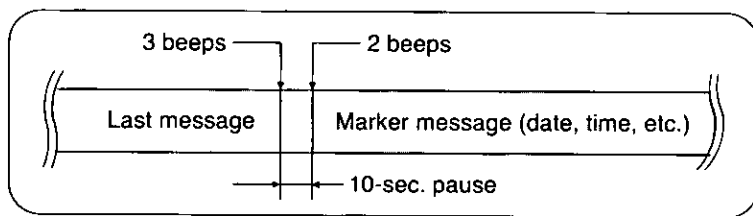

Leave your message after the last 2 beeps.

Hang up when finished. The marker message is recorded after the last message on the tape.

Resetting the tape for future messages

After listening to the recorded messages, you can reset the tape to record future messages from the beginning of the tape.

After all the messages have been played back or even while they are being played;

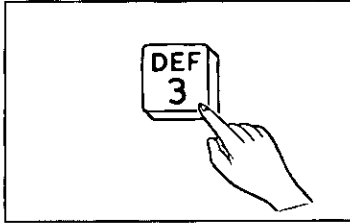

Press **3**, then hang up.

The unit rewinds the tape to the beginning. Future messages will be recorded and the previously recorded messages are erased.

If you have used New Messages Playback;

1

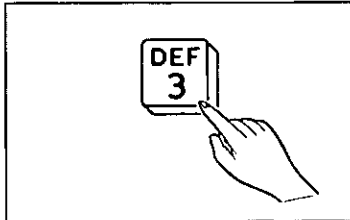

Press **3**.

The unit rewinds the tape to the beginning of the newly recorded messages, then beeps.

2

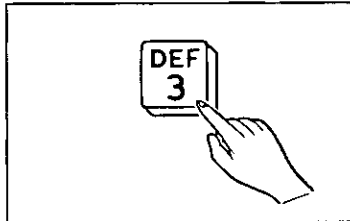

Press **3** again after hearing the beep.

The unit rewinds the tape to the beginning of the previously recorded messages.

If you have reset the tape by mistake;

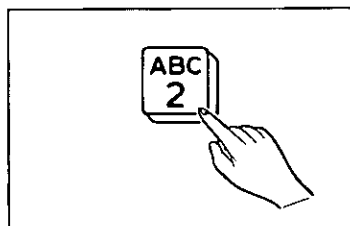

Press **2** after the tape has been reset.

One beep sounds.

The unit advances the tape to the end of the recorded messages.

Answer back

You can monitor the sound in the room where the unit is installed for about 30 seconds. This feature also allows you to speak with anyone in the room where the unit is installed.

1

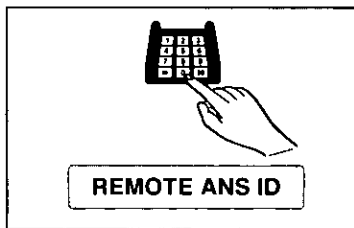

Call your unit, then dial your REMOTE ANS ID while the greeting message is playing.

2

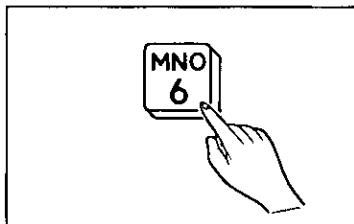

Press 6 after hearing the beeps that indicate the number of recorded messages.

The speaker-phone of the unit in the room is turned on for 30 seconds.

NOTES:

- To continue monitoring, press 6 again within 10 seconds after hearing one beep.
- To talk to the other party in the room, inform them to lift the handset or press the **SP-PHONE** button.
- If the **VOLUME** control of the unit has been lowered, the party may not be able to hear your voice from the built-in speaker.

Skipping the greeting message for incoming message recording mode

Callers can leave a message on your unit without listening to your greeting message.

1

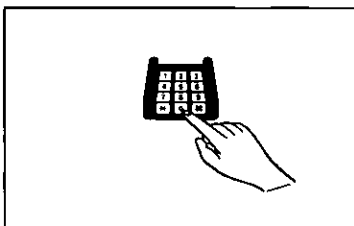

Call your unit.

2

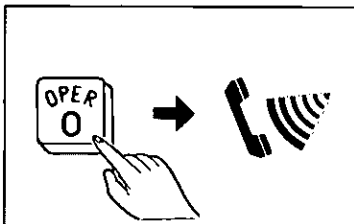

Press 0 while the greeting message is playing.

After hearing a long beep, speak clearly and loudly to leave a message.

Re-recording a greeting message

You can change the content of your greeting message from a remote telephone.

1

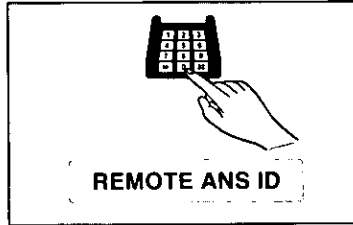

Call your unit, then dial your REMOTE ANS ID while the greeting message is playing.

2

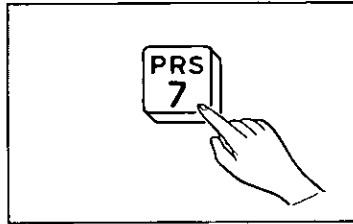

Press 7 to start re-recording after hearing the beeps that indicate the number of recorded messages.

3

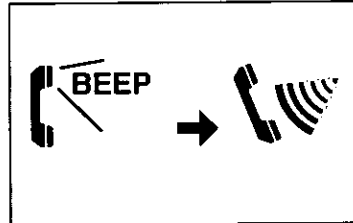

After hearing a long beep, speak clearly and loudly for up to 16 seconds.

4

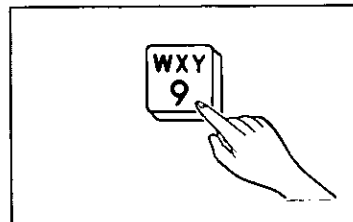

When finished, press 9.

The new greeting message is played to confirm the change.

NOTE:

If you pause for over 2 seconds while recording, the unit beeps and stops the greeting message recording. In this case, repeat from step 2 within 10 seconds.

Setting the Message Alert

When this feature is on, the unit will let you know with an alert if a caller's message has been recorded or not.

When a new message is recorded in the *ANS/FAX* mode, a slow beep will sound and the indicator will blink. When you hear the beep sound, play back the message(s). The beep sound will stop and the indicator will stop blinking.

To set the Message Alert:

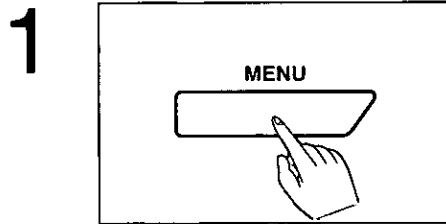

Press the **MENU** button until the following is shown.

PROGRAM[1.DATE 2.TEL
3.SYSTEM 4.REPORT]

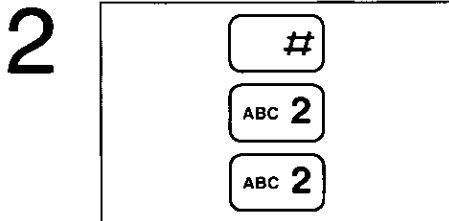

Press #, then press **22**.

MESSAGE ALERT
=OFF [1.ON 2.OFF]

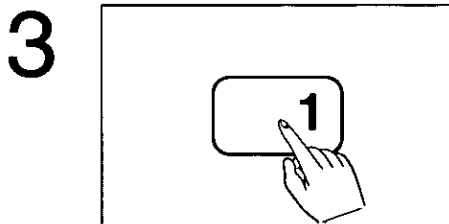

Press **1** to activate this feature.

MESSAGE ALERT
=ON [1.ON 2.OFF]

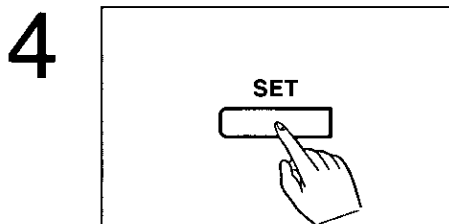

Press the **SET** button to store your selection in memory.

PROGRAM[1.DATE 2.TEL
3.SYSTEM 4.REPORT]

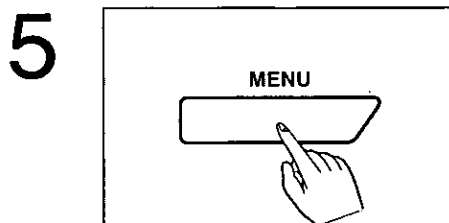

Press the **MENU** button to end the operation.

The display shows the current time.

Voice Contact

Initiating voice contact

While transmitting or receiving a document, you may wish to speak to the other party. If the other party's unit is equipped with a voice contact feature, you can initiate voice contact and notify the other party that you wish to speak after the transmission/reception is completed. The other party's fax will emit a distinctive ring that indicates that a voice conversation is required. This saves the extra expense and time of making a subsequent telephone call to discuss information sent over the fax.

1

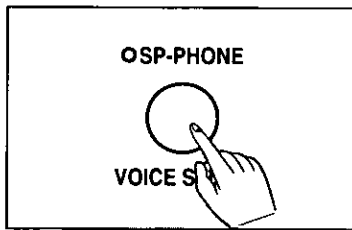

Press the **SP-PHONE/VOICE STDBY** button or lift the handset while transmitting or receiving the documents.

SENDING	PXX
VOICE	STANDBY

2



When the other party answers, start speaking.

—If you initiate voice contact while transmitting documents, you can speak after all the documents have been transmitted.

—If you initiate voice contact while receiving documents, you can speak after receiving the current page of the documents.

Receiving a request for voice contact

If the other party initiates voice contact during transmission or reception, your unit will emit a distinctive ring after the fax is completed.



When a distinctive ring is heard, lift the handset or press the **SP-PHONE** button, then start speaking.

RECEIVING	PXX
PICK UP THE	HANDSET

NOTE:

If you do not answer within 10 seconds after hearing several rings indicating the request for voice contact, one of the following occurs:

- When the unit is in the *ANS/FAX* mode, it plays back your greeting message and records the voice-message on the tape.
- When the unit is in the *TEL/FAX* mode, the line is disconnected.
- When the unit is in the *FAX* mode, the line is disconnected.
- When the unit is in the *TEL* mode, the line is disconnected.

TONE, FLASH and PAUSE Button Usage

TONE button (Temporary tone dialing)

This function is only used when your line has a rotary pulse dial service. Pressing the TONE (*) button allows you to change from pulse to tone mode during a dialing operation and enter special tones and codes to operate the answering device, electronic banking services, call processing services and other special services.

Using the TONE button:

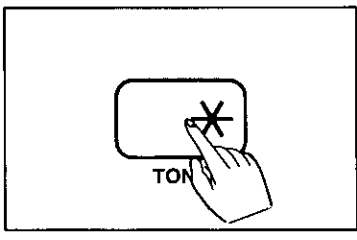

Press the **TONE** (*) button.

When you hang up, the unit automatically returns to pulse mode.

NOTES:

- Store "TONE" in memory as explained on pages 4-2 to 4-8.
- Pressing the TONE button counts as 1 digit while programming.

FLASH button

The FLASH button is used to access some of the features of your host PABX (private automatic branch exchange).

For further details, please contact your local telephone company for information about the availability of these services in your area.

Using the FLASH button:

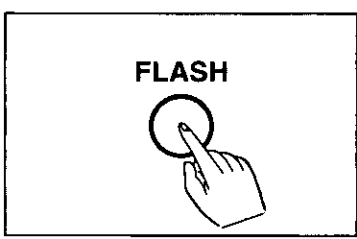

Press the **FLASH** button briefly when required.

NOTES:

- Store "FLASH" in memory as explained on pages 4-2 to 4-8.
- Pressing the FLASH button counts as 1 digit while programming.

PAUSE button

The PAUSE button is used in a dial sequence to access an outside line. Pressing the PAUSE button creates a dialing delay.

Using the PAUSE button:

Example: Line access number 9

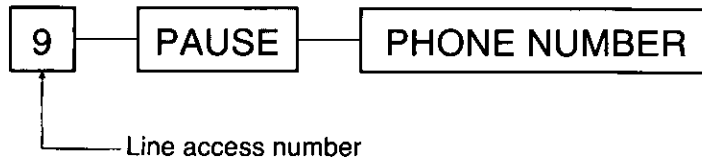

NOTES:

- Store "PAUSE" in memory as explained on pages 4-2 to 4-8.
- Pressing the PAUSE button counts as 1 digit while programming.

Combination dialing

The following combination of dialing methods can be used.

- Manual dialing and automatic dialing
- Pulse and Tone dialing
- Plural memory stations

Setting Day/Night Mode

You may wish to use the unit as a telephone and facsimile (*TEL/FAX* mode) during the business hours and switch to the answering device (*ANS/FAX* mode) during off hours. With this feature on, the unit automatically switches from *TEL/FAX* mode to *ANS/FAX* mode at a preprogrammed time without the operator's assistance. In the Night mode, the unit receives a call without ringing.

1

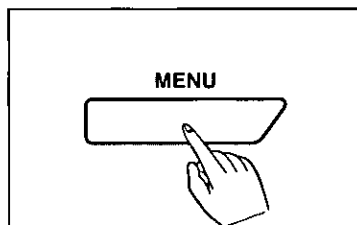

Press the **MENU** button until the following is shown.

PROGRAM[1.DATE 2.TEL
3.SYSTEM 4.REPORT]

2

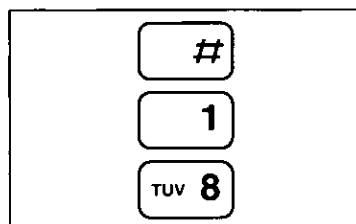

Press #, then press **18**.

DAY/NIGHT
=OFF [1.ON 2.OFF]

3

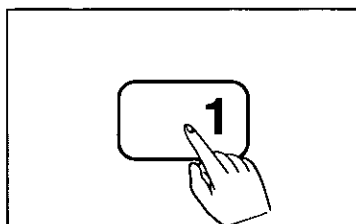

Press **1** to turn on the Day/Night Mode.

DAY/NIGHT
=ON [1.ON 2.OFF]

4

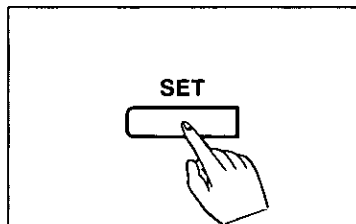

Press the **SET** button.

SET DAY MODE TIME
12:00AM [*=AM #=PM]

5

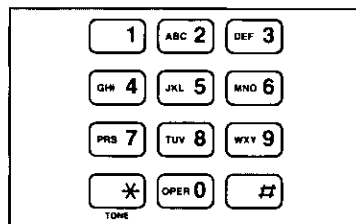

Enter the time at which the Day mode (*TEL/FAX* mode) starts.

Example: The *TEL/FAX* mode starts at 8:00AM.
Press **0 8 0 0**, then press * to select AM.

SET DAY MODE TIME
08:00AM [*=AM #=PM]

(continued)

6

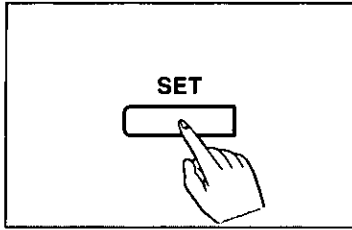

Press the **SET** button.

SET NIGHT MODE TIME
12:00AM [*=AM #=PM]

7

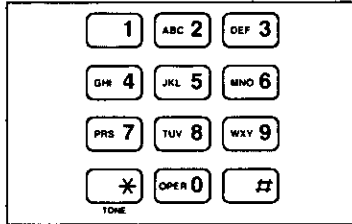

Enter the time at which the unit switches to the Night mode (ANS/FAX mode).

Example: The ANS/FAX mode starts at 5:00PM.
Press 0 5 0 0, then press # to select PM.

SET NIGHT MODE TIME
05:00PM [*=AM #=PM]

8

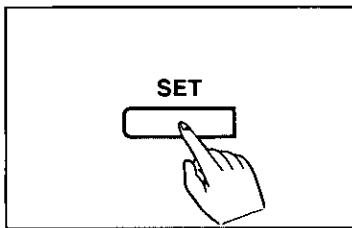

Press the **SET** button to store the program in memory.

PROGRAM[1.DATE 2.TEL
3.SYSTEM 4.REPORT]

9

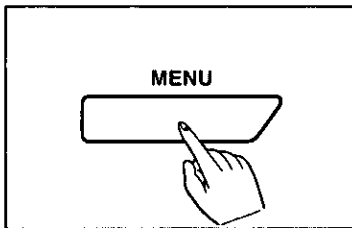

Press the **MENU** button to end the operation.

The display shows the current time.

NOTE:

If you select another receiving mode manually while this feature is on, the unit keeps the receiving mode that you select until either Day or Night mode starts.

Setting Silent Fax Recognition Ring

When a voice call is received in the *TEL/FAX* mode, the unit will ring three times before it switches automatically to fax. When an automatic fax transmission is received in the *TEL/FAX* mode, the unit will receive the fax without ringing (we call this "Silent Fax Recognition Ring").

Change the number of rings choosing the number among "3" (three rings) through "8" (eight rings).

The three rings is preset as default.

NOTES:

- This feature is effective only in the *TEL/FAX* mode.
- Telephone fees are charged to the calling party from the first ring.

To change the number of rings:

1

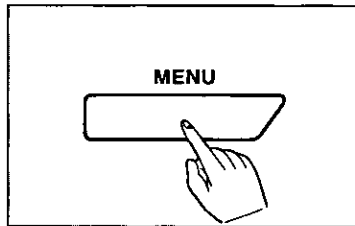

Press the **MENU** button until the following is shown.

PROGRAM[1.DATE 2.TEL
3.SYSTEM 4.REPORT]

2

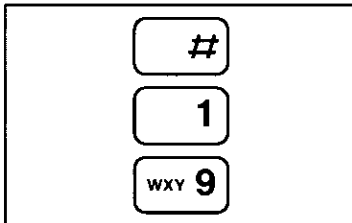

Press #, then press **19**.

SILENT FAX RECO.
RING=3 [3-8]

3

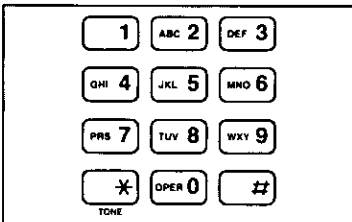

Enter the desired number (choose from 3 to 8).

4

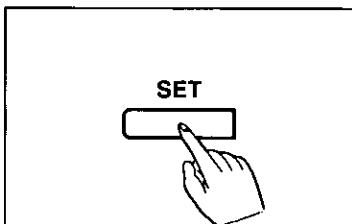

Press the **SET** button to store your selection in memory.

PROGRAM[1.DATE 2.TEL
3.SYSTEM 4.REPORT]

5

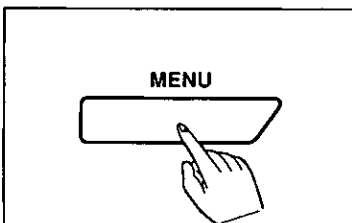

Press the **MENU** button to end the operation.

The display shows the current time.

Resetting the Setup Features

Use this operation to return the advanced features of #10 through #38 (see page 2-3) to their initial default settings.

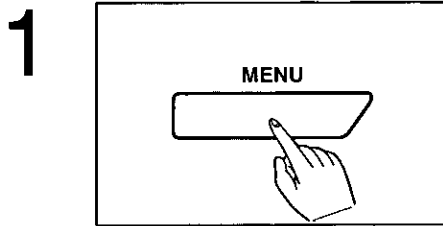

Press the **MENU** button until the following is shown.

PROGRAM[1.DATE 2.TEL
3.SYSTEM 4.REPORT]

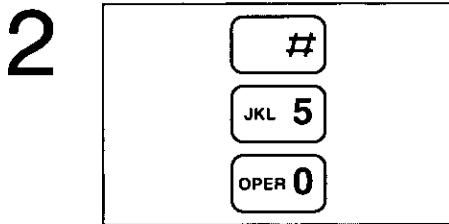

Press #, then press **50**.

SET DEFAULT
=NO [1.YES 2.NO]

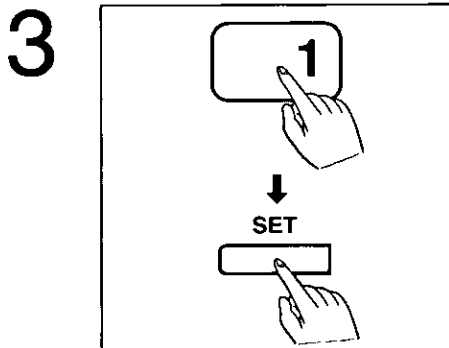

Press **1**, then press the **SET** button.

PARAMETER RESET OK?
=NO [1.YES 2.NO]

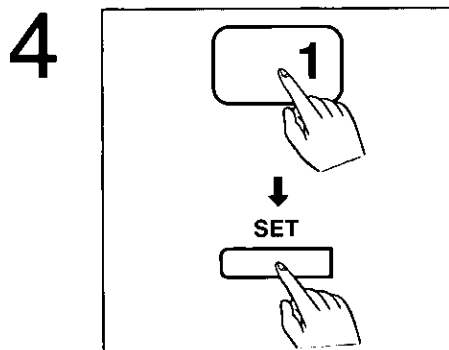

Press **1**, then press the **SET** button.

DEFAULT SETTING
COMPLETED!

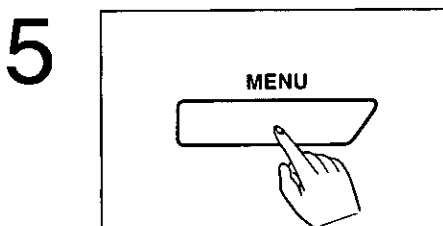

Press the **MENU** button to end the operation.

The display shows the current time.

Chapter 6

Printing Reports and Lists

Table of contents

Activity Report (JOURNAL Report)	6-2
Setting the JOURNAL AUTO PRINT	6-3
Printing a JOURNAL report manually	6-4
List of Stored Phone Numbers (TELEPHONE NUMBER LIST)	6-5
Printing a TELEPHONE NUMBER LIST	6-6
Basic Feature List	6-7
Advanced Feature List	6-8

When the display shows any error message, see page 7-2 for corrective measures.

Activity Report (JOURNAL Report)

You can obtain a record of the last 35 transactions (transmissions and receptions) automatically or manually.

When the JOURNAL AUTO PRINT is set to **AUTO**, the report prints automatically after every 35 transactions. After each 35 transactions, the report clears and the list begins again. It may also be printed on request.

When you set this feature to **MANUAL**, the JOURNAL report data is stored until the memory becomes full. Once the memory is full, the oldest entry in the memory is deleted when a new transaction takes place.

This feature has been preset to **AUTO** as the default.

These reports are useful for keeping records of telephone usage or verifying telephone long distance charges.

Print time: Hour/Minute AM/PM

Print date: Month/Day/Year

```
***** JOURNAL *****
*
*
* Jan. 04 1994 11:30AM
*
* NO.  OTHER FACSIMILE  START TIME  USAGE TIME  MODE  PAGES  RESULT  CODE
*-----
* 01  1234567            Jan. 1 11:28AM  01'20    TX    02    OK
* 02  9998765            Jan. 1 11:52AM  00'56    TX    01    OK
* 03  <<< G3 >>>        Jan. 1 11:58AM  00'32    RX    01    OK
* 04  5556677            Jan. 1 12:19PM  01'48    TX    03    OK
* 05  +987 1234          Jan. 1 12:35PM  01'41    RX    03    OK
* 06  <S01>              Jan. 1  1:14PM  02'40    TX    05    OK
* 07  7776543            Jan. 1  1:27PM  01'03    TX    01    OK
* 08  4445566            Jan. 1  2:46PM  01'18    TX    02    OK
* 09  <A27>              Jan. 1  3:17PM  00'35    TX    00    PRESSED THE STOP KEY (A2)
* 10  <<< G3 >>>        Jan. 1  3:19PM  01'21    RX    03    OK
* 11  661234            Jan. 1  3:38PM  02'25    TX    04    OK
* 12  <S06>              Jan. 1  4:20PM  01'02    TX    01    OK
* 13  +1111111          Jan. 1  4:21PM  02'18    TX    04    OK
* 14  +1111111          Jan. 1  4:22PM  02'18    TX    04    OK
*
* 22334455            Jan. 4  8:16AM  01'22    TX    03    OK
* 23  <<< G3 >>>        Jan. 4  9:36AM  01'22    TX    03    OK
* 24  5556677            Jan. 4 10:26AM  01'32    TX    03    OK
* 25  9996675            Jan. 4 11:28AM  01'20    TX    03    OK
*****
```

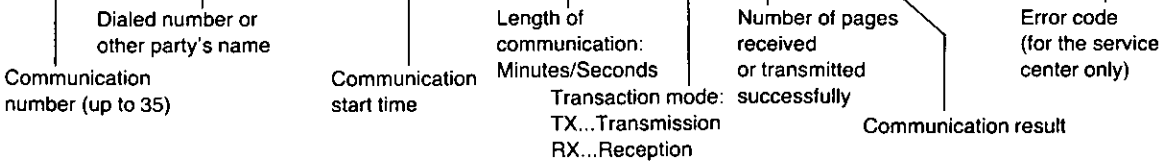

Explanation of communication result:

- OK: Successful communication
- PRESSED THE STOP KEY: The fax communication was interrupted since the STOP (Ⓢ) button was pressed.
- DOCUMENT JAMMED: A document was jammed.
- NO DOCUMENT: The document was not fed into the unit properly.
- PRINTER OVERHEATED: Printing head was overheated.
- PAPER OUT: The unit is out of recording paper.
- THE COVER WAS OPENED: The front lid or back lid was opened.
- COMMUNICATION ERROR: Transmission or reception error.
- PASSCODE FAILED: Passcode communication failed.
- JUNK MAIL PROH. REJECT: The unit reject fax reception when the junk mail prohibitor is on.
- NO RESPONSE: Receiving unit is busy or out of recording paper.
- PAPER JAMMED: The recording paper was jammed.

Printing Reports and Lists

Setting the JOURNAL AUTO PRINT

1

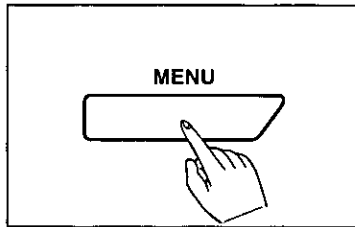

Press the **MENU** button until the following is shown.

PROGRAM[1.DATE 2.TEL
3.SYSTEM 4.REPORT]

2

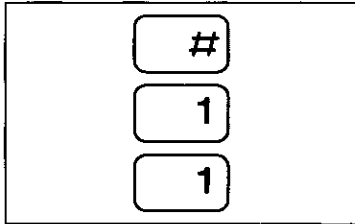

Press #, then press 11.

JOURNAL=AUTO
[1.AUTO 2.MANUAL]

3

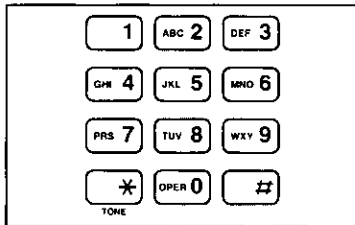

Press the number of the selection you desire.

Setting selections are:

- 1: AUTO (Prints a report every 35 transactions automatically.)
- 2: MANUAL

4

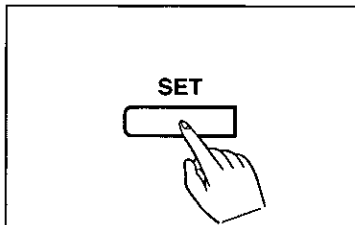

Press the **SET** button to store your selection in memory.

PROGRAM[1.DATE 2.TEL
3.SYSTEM 4.REPORT]

5

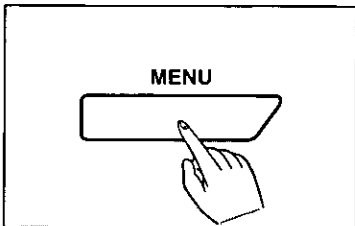

Press the **MENU** button to end the operation.

The display shows the current time.

Printing a JOURNAL report manually

You can print a report of the current JOURNAL upon request. This will not clear the report which will continue until 35 transactions are completed.

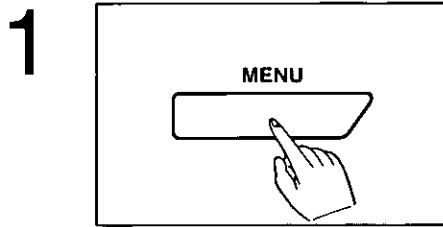

Press the **MENU** button until the following is shown.

PROGRAM[1.DATE 2.TEL
3.SYSTEM 4.REPORT]

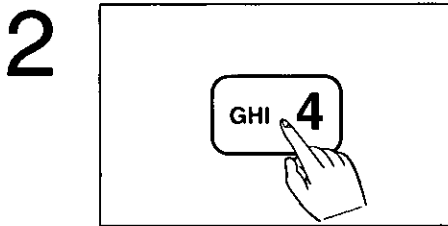

Press 4.

SELECT NO.[1.SYSTEM
2.TEL NO. 3.JOURNAL]

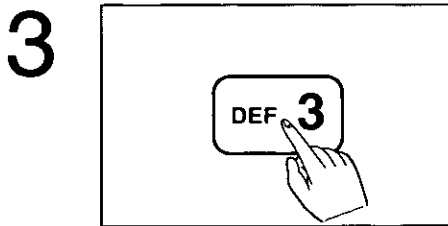

Press 3.

The unit starts printing.
If there have been no transactions, no JOURNAL is printed.

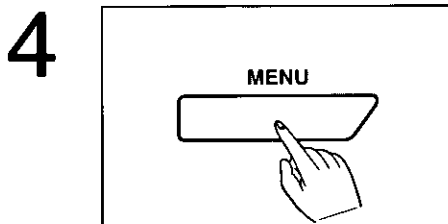

Press the **MENU** button to end the operation.

The display shows the current time.

List of Stored Phone Numbers (TELEPHONE NUMBER LIST)

You can print a list of the numbers programmed for one touch dialing and speed dialing. Use this feature to confirm that you have correctly stored phone numbers.

Sample of TELEPHONE NUMBER LIST

```

***** TELEPHONE NUMBER LIST *****
<< STATION KEY LIST >>
-----
      PHONE NUMBER          NAME          PHONE NUMBER          NAME
01 T092-123-4567          Panasonic A    07 R999-1234
02 T83-555-1234          Panasonic B    08 T(          )
03 T012-999-8877          Panasonic C    09
04 T83P4567              10
05 T987-6543             11
06                        12

<< AUTO KEY LIST >>
-----
      PHONE NUMBER          NAME          PHONE NUMBER          NAME
00 T111-2233              50 T222-3344          Panasonic D
01 R765-4321              51 T9P092-555-6677    Panasonic E
02 T345F6789              52
03 T092[          ]      53
04                        54
05                        55
06                        56
07                        57
08                        58
09                        59
10                        60
11                        61
12                        62
13                        63
14                        64
15                        65
16                        66
17                        67
18                        68
19                        69
20
  
```

Secret phone number

Codes in each phone number:

- T: Shows that you have entered the telephone number in the TONE dialing mode.
- R: Shows that you have entered the telephone number in the PULSE (rotary) dialing mode.
- P: Shows that you have entered PAUSE.
- F: Shows that you have entered FLASH.

Printing Reports and Lists

Printing a TELEPHONE NUMBER LIST

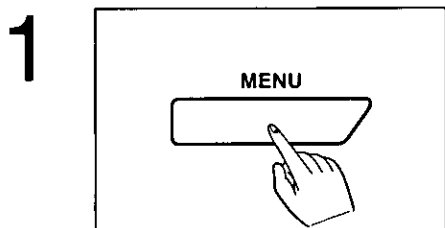

Press the **MENU** button until the following is shown.

PROGRAM[1.DATE 2.TEL
3.SYSTEM 4.REPORT]

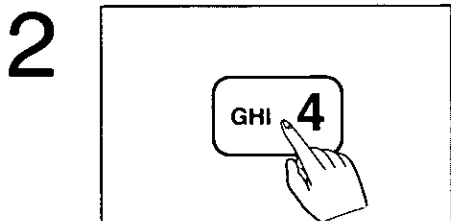

Press 4.

SELECT NO.[1.SYSTEM
2.TEL NO. 3.JOURNAL]

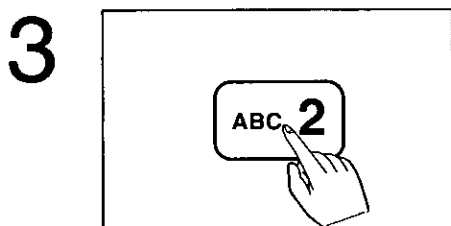

Press 2.

The unit starts printing.

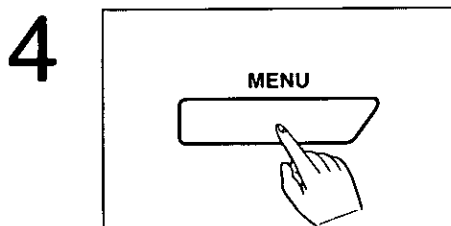

Press the **MENU** button to end the operation.

The display shows the current time.

Basic Feature List

Sample of Basic Feature List

Code	Functions	Settings [selections]
***** < BASIC FEATURE LIST > *****		
#01	SET DATE	= Jan. 01 1994 12:00AM
#02	YOUR LOGO (I.E. COMPANY OR INDIVIDUAL NAME)	=
#03	YOUR TELEPHONE NUMBER	=
#04	PRINT TRANSMISSION REPORT	= ERROR [1=ERROR 2=ON 3=OFF]
#05	ANS/FAX RING COUNT	= 1 [1...4 0=TOLL SAVER *=RINGER OFF]
#06	FAX RING COUNT	= 1 [1...4]
#07	RECORDING TIME FOR ANS	= VOX [1=VOX 2=1MIN]
#08	REMOTE ANS ID	= 111
#99	PRINT ADVANCED FEATURE LIST	

To obtain a Basic Feature List:

1

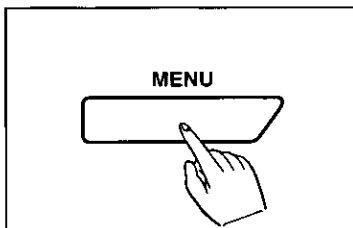

Press the **MENU** button until the following is shown.

PROGRAM[1.DATE 2.TEL
3.SYSTEM 4.REPORT]

2



Press 4.

SELECT NO.[1.SYSTEM
2.TEL NO. 3.JOURNAL]

3

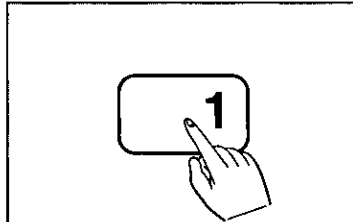

Press 1.

The unit starts printing.

4

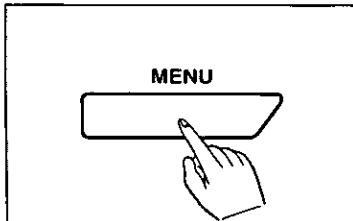

Press the **MENU** button to end the operation.

The display shows the current time.

Advanced Feature List

Sample of Advanced Feature List

Code	Functions	Settings	[selections]
***** < ADVANCED FEATURE LIST > *****			
#10	LOGO POSITION	= OUT	[1=OUT 2=IN 3=OFF]
#11	JOURNAL AUTO PRINT	= AUTO	[1=AUTO 2=MANUAL]
#12	NETWORK PASSCODE	= 0000	
#13	TX PASSCODE CHECK	= OFF	[1=ON 2=OFF]
#14	RX PASSCODE CHECK	= OFF	[1=ON 2=OFF]
#18	DAY/NIGHT MODE	= OFF	[1=ON 2=OFF]
	DAY MODE TIME	= 12:00 AM	
	NIGHT MODE TIME	= 12:00 AM	
#19	SILENT FAX RECOGNITION RING	= 3	[3...8]
#20	REMOTE FAX ACTIVATION CODE	= **	
#21	PAPER SAVE FUNCTION	= OFF	[1=ON 2=OFF]
#22	MESSAGE ALERT	= OFF	[1=ON 2=OFF]
#23	RING PATTERN DETECTION	= OFF	[1=A 2=B 3=C 4=D 5=OFF]
#24	EXTENSION COPY		
#28	PRINTER TEST		
#38	JUNK MAIL PROHIBITOR	= OFF	[1=ON 2=OFF]
	JUNK MAIL PROHIBITOR ID	= 22	
#50	SET DEFAULT (#10 TO #38)		
#9000*	(SERVICE DATA SET UP)		← This code is only for a service center.
<DELAYED XMT>			
	DELAYED MODE	= OFF	
	PHONE NUMBER	=	
	START TIME	= 12:00 AM	
	PAGE COUNTER	= 0	

To obtain an Advanced Feature List:

1

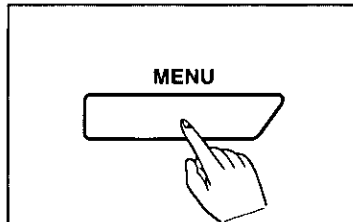

Press the **MENU** button until the following is shown.

PROGRAM[1.DATE 2.TEL
3.SYSTEM 4.REPORT]

2

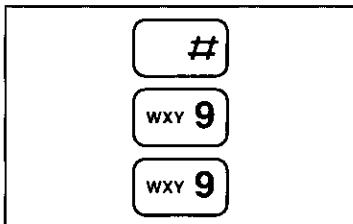

Press #, then press 99.

ADVANCED SETTINGS
PRESS START TO PRINT

3

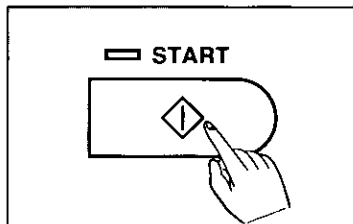

Press the **START** button.

PRINTING
ADVANCED LIST

The unit starts printing.

4

Press the **MENU** button to end the operation.

Chapter 7

Troubleshooting and Maintenance

Table of contents

Troubleshooting	7-2
Error messages	7-2
General corrective measures	7-3
Clearing a document jam	7-6
Clearing a recording paper jam	7-7
Maintenance	7-9
Cleaning the microcassette compartment	7-9
Cleaning the document feeder unit	7-10
Cleaning the thermal head	7-10
Printing a test pattern	7-11

When the display shows any error message, see page 7-2 for corrective measures.

Troubleshooting

Error messages

DISPLAY MESSAGES	CAUSE & REMEDY
SAT JAN 1 3:00PM 00 CHECK COVER	<ul style="list-style-type: none">•The cover of the recording paper unit is open. Close it.
SAT JAN 1 3:00PM 00 CHECK DOCUMENT	<ul style="list-style-type: none">•The document has not been fed into the unit properly. If the paper rollers inside the document feeder unit are dirty, clean them and then reinsert the document (see page 7-10).
SAT JAN 1 3:00PM 00 CHECK CASSETTE TAPE	<ul style="list-style-type: none">•The tape is broken or not installed. Install a new one (see page 1-11).•Tape is full. Reset it or use the other side.
SAT JAN 1 3:00PM 00 CHECK MEMORY	<ul style="list-style-type: none">•Memory (phone numbers, parameters, etc.) has been erased. Reprogram them.
SAT JAN 1 3:00PM 00 RECORD GREETING	<ul style="list-style-type: none">•The greeting message is not recorded. Record your greeting message.
SAT JAN 1 3:00PM 00 OUT OF PAPER	<ul style="list-style-type: none">•The unit ran out of recording paper. Replace it.
SAT JAN 1 3:00PM 00 PAPER JAMMED	<ul style="list-style-type: none">•The recording paper is jammed. Reinstall it.•Make sure that there is no slack in the recording paper.
UNIT OVERHEATED, PLEASE WAIT	<ul style="list-style-type: none">•The unit is too hot. Leave it as it is and allow it to cool down.
SAT JAN 1 3:00PM 00 REMOVE DOCUMENT	<ul style="list-style-type: none">•A document is jammed. Open the cover of the document feeder unit and remove the document that causes a problem.•Attempted to transmit a document longer than 600 mm (23$\frac{5}{8}$"). Press the STOP (⊘) button and remove it.
SAT JAN 1 3:00PM 00 TRANSMIT ERROR	<ul style="list-style-type: none">•Transmission error. Try again.•This display appears when your network passcode does not correspond to the other party. Check the network passcode.

General corrective measures

GENERAL

PROBLEM	CAUSE & REMEDY
I cannot transmit or receive a document or cannot talk.	The line cords are connected incorrectly or not connected. —Confirm the connections. See page 1-9.
The unit does not operate properly.	—Turn the POWER switch off, then turn it on again. See page 1-15.
The ALARM indicator lights.	The cover of the recording paper unit is open. —Close it firmly.
The unit does not ring.	The RINGER volume selector is set to the OFF position. —Set the RINGER volume selector to the HIGH or LOW position. See page 1-14.

TRANSMISSION

PROBLEM	CAUSE & REMEDY
The ALARM indicator flashes after transmission.	A transmission error has occurred. —Try again. See page 3-4.
The ALARM indicator lights during transmission.	A document more than 600 mm (23 ⁵ / ₈ ") is being transmitted. —Divide the document so that the length can be shorter than 600 mm (23 ⁵ / ₈ "). See page 3-2. A document causes a jam. —Remove it, then try again. See page 7-6. The unit has been connected to a line that has special telephone services, such as call waiting. —Connect the unit to a line that does not have such services.
The other party complains that letters on the document are distorted.	If your line has special telephone services such as call waiting, the service may have been activated during the fax reception. —Connect the unit to a line that does not have such services. Another telephone connected to the same line as your unit is connected is hung off. —Hang up and try again.
The other party complains that a dirty pattern or black lines appear on the received documents.	The glass and rollers inside the document feeder unit are dirty. —Clean them. See page 7-10.
The unit does not feed the document properly.	The paper rollers inside the document feeder unit are dirty. —Clean them (see page 7-10).

TRANSMISSION (continued)

Problems when transmitting international facsimile.	—Use the overseas transmission mode. See page 5-16.
---	--

RECEIVING

PROBLEM	CAUSE & REMEDY
The ALARM indicator lights during copying or receiving.	The recording paper causes a jam. —Remove it. See page 7-7.
Unable to receive documents.	The recording paper is not installed. —Install the recording paper. See pages 1-12 and 1-13.
Unable to receive documents automatically.	The receive mode of the unit is set to the <i>TEL</i> mode. —Operate the manual reception (see page 3-6) or set the receive mode to <i>ANS/FAX</i> , <i>TEL/FAX</i> or <i>FAX</i> mode. See pages 3-7 and 3-8. Your greeting message may be too long. —Shorten your greeting message (see pages 1-16 and 1-17) or ask the other party to press “*” (ASTERISK) then start to transmit a document. —Set the number of rings to answer to “1”. See pages 2-12 to 2-13.
Recording image is faint and I cannot read it well.	The sender transmitted a faint document. —Request the sender to transmit a clearer copy of the document.
The START indicator flashes for about 40 seconds after the unit receives a call automatically, but nothing is recorded.	—The caller hangs up during or immediately after your greeting message plays. This may occur if the disconnected signal is not transmitted from the telephone company's central office.
Problems when receiving international facsimiles.	Your greeting message may be too long. —Shorten your greeting message to 10 seconds or less. See pages 1-16 and 1-17. The RX SPEED may need to be set to 4800 bps. —Call your service center. See pages 8-7 and 8-17.
Received or copied image is distorted.	The thermal head is dirty. —Clean it with a cloth moistened with denatured alcohol. See page 7-10.

ANSWERING DEVICE & TELEPHONE

PROBLEM	CAUSE & REMEDY
The Call Counter in the display shows "--".	There has been a power failure. —Confirm whether voice-messages are recorded on the tape or not. See pages 3-13 and 3-14. The microcassette tape was not rewound when the unit was turned on. —Rewind the tape. See page 3-12.
The unit has been set to the <i>ANS/FAX</i> mode, but no voice-messages have been recorded.	The tape is not installed properly or it is broken (cut, worn out or twisted). —Install the tape properly or replace it with a new one. See page 1-11.
When the tape is played, the sound level is low or nothing can be heard.	The speaker volume is low. —Raise the sound level using the VOLUME control. The head in the cassette deck compartment is dirty. —Clean it. See page 7-9.
I have played back all the recorded messages, and I want to record the next call after the last message.	—Leave the unit as it is after hearing the messages.
I cannot retrieve recorded messages from a remote phone.	—Make sure that you use your REMOTE ANS ID number correctly. When you use your REMOTE ANS ID number, press the buttons firmly.
Some voice-messages have not been fully recorded.	The calling party control (CPC) should be set to "B". —Call your service center. See pages 8-7 and 8-17.
When a caller hangs up after leaving a message, the tape does not stop.	VOX TIME should be set to 4 seconds. —Call your service center. See pages 8-7 and 8-17.

Clearing a document jam

If an original document becomes jammed in the document feeder unit, the ALARM indicator lights and a long beep is heard. Remove the document that causes a problem by following steps below.

1

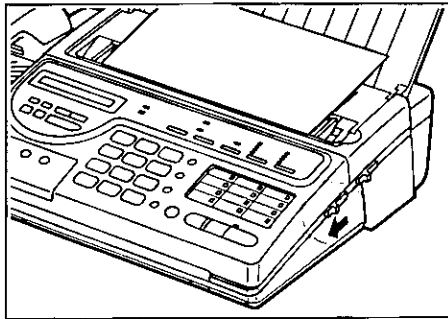

Slide the **FRONT LID OPEN** lever forward to open the document feeder unit.

2

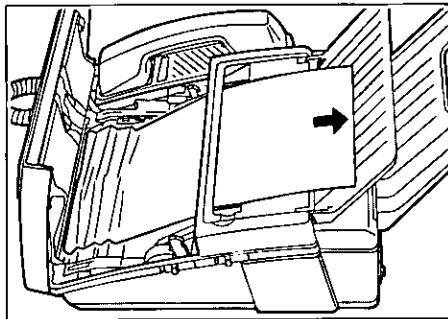

Remove the document that causes a problem carefully.

3

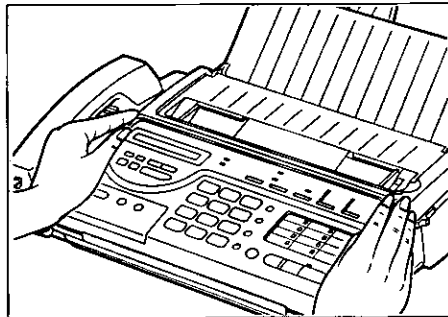

Then close the document feeder unit carefully by pushing down on both ends gently.

Clearing a recording paper jam

When the unit does not eject a recording paper during receiving, the recording paper has jammed. Remove the jammed paper by following the steps below.

1

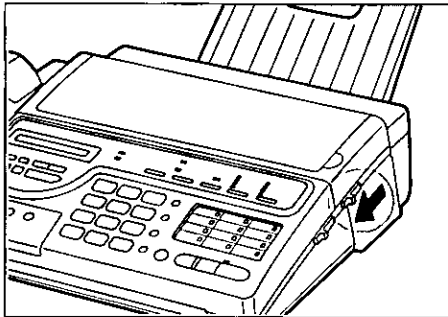

Slide the **BACK LID OPEN** lever forward to open the recording paper unit.

2

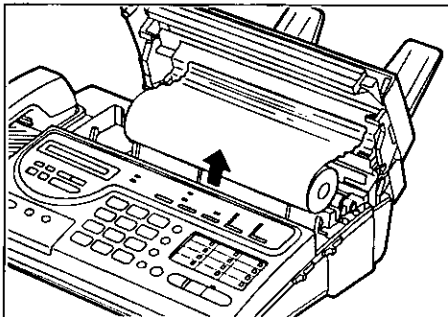

Remove the jammed paper.

3

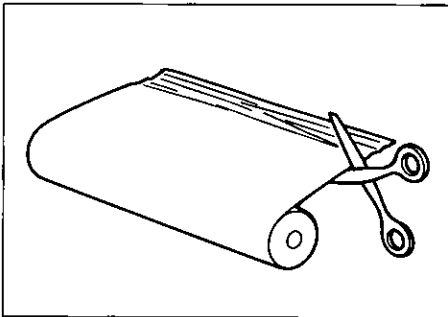

Cut off the wrinkled portion.

4

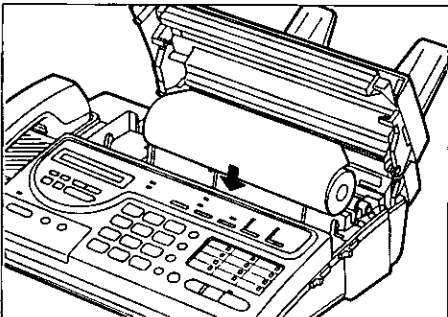

Replace the recording paper roll.

Make sure that the shiny side of the paper is facing up and that there is no slack in the paper roll.

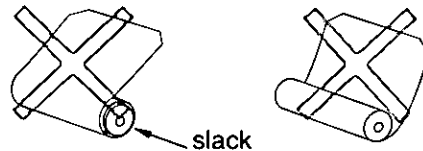

(continued)

5

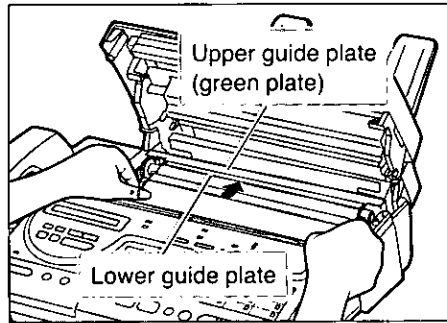

Then insert its leading edge between the upper guide plate (green plate) and the lower guide plate and pull the paper a few centimeters (one or two inches) out of the unit.

If the recording paper cannot be inserted; Close the recording paper compartment cover to reset the paper cutter, then open it by sliding the **BACK LID OPEN** lever and insert the paper again.

6

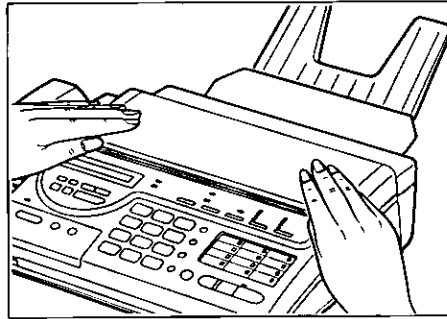

Close the recording paper unit carefully by pushing down on both ends gently.

When the unit is on, the recording paper will project itself slightly and be cut automatically.

NOTE:

When re-installing a recording paper roll with 1/2 inch core, remember to fix the paper roll holders to the recording paper (see page 1-13).

Maintenance

Be sure that the AC plug is disconnected from the outlet before performing any maintenance.

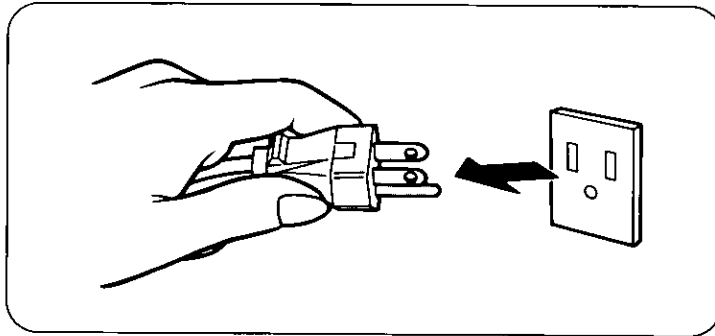

Cleaning the microcassette compartment

Dirt and residue from the tape may adhere to the head and capstan, causing distortion. Clean these parts periodically in the manner described below for the best sound quality.

1. Open the cassette compartment cover.
2. Remove the microcassette tape.
3. Clean the head surfaces, pinch roller and capstan with a cotton swab.
If these surfaces are extremely dirty, wipe them with a cotton swab dampened with denatured alcohol, then wipe them with a dry soft cloth.

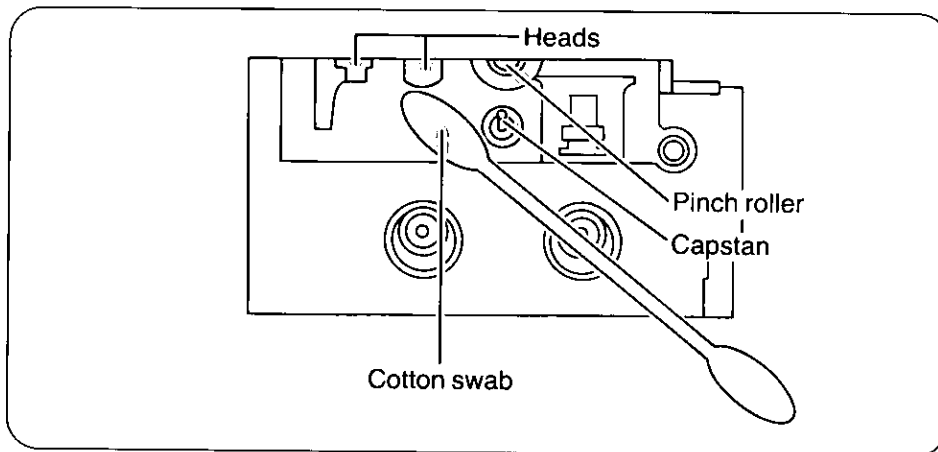

NOTES:

- Do not bring magnetic or metal objects, such as a screwdriver, near the head assembly, as such objects could magnetize the heads.
- Do not oil any part of the unit.

Cleaning the document feeder unit

Clean the inside of the document feeder unit by following the steps below;
—when the unit does not feed the document properly.
—when a dirty pattern or black bands appear on a copied or transmitted document.

1. Turn the **POWER** switch to the "o" (OFF) position and open the document feeder unit.
2. Clean the rubber and the paper rollers rotating them with a cloth moistened with isopropyl rubbing alcohol, then dry thoroughly to prevent paper jams.
3. Clean the glass and the white plate with a dry soft cloth.

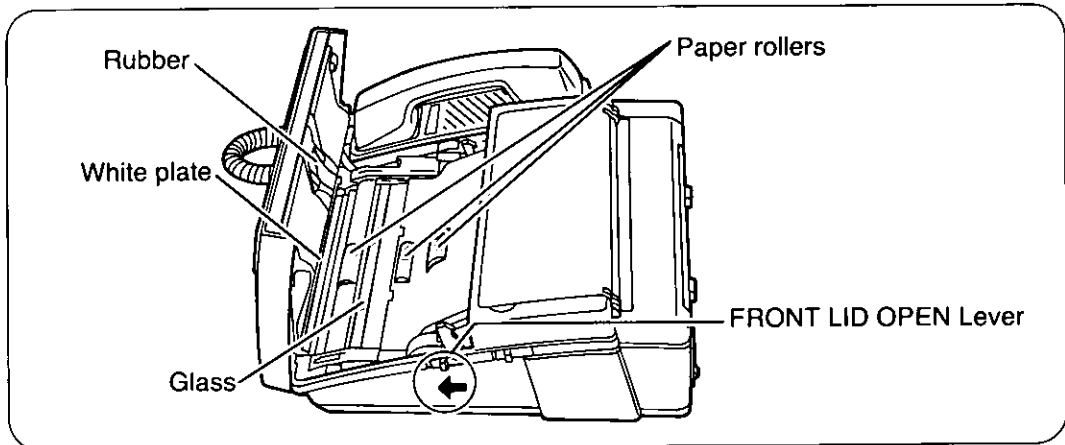

4. Close the document feeder unit and turn the **POWER** switch to the "I" (ON) position.

Cleaning the thermal head

If a dirty pattern or black bands appear on a copied or received document, clean the thermal head inside the recording paper unit by following the steps below.

1. Turn the **POWER** switch to the "o" (OFF) position and open the recording paper unit.
2. Remove the recording paper from the unit.
3. Clean the thermal head with a cloth moistened with isopropyl rubbing alcohol, then dry thoroughly.

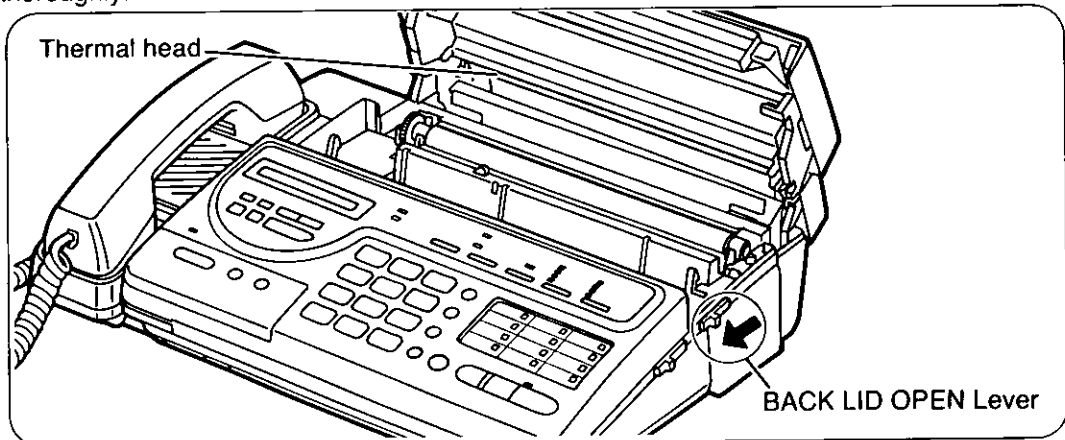

4. Close the recording paper unit and turn the **POWER** switch to the "I" (ON) position.

NOTES:

- To prevent malfunction due to static electricity, do not use a dry cloth and do not touch the thermal head with your finger directly.
- When finished, confirm the print quality by printing the test pattern. See page 7-11.

Printing a test pattern

You can check the print quality of your unit by printing the test pattern. If the test pattern has any blurred points or lines or a dirty pattern, please clean the thermal head following the instructions on page 7-10.

To obtain the test pattern, follow the steps below.

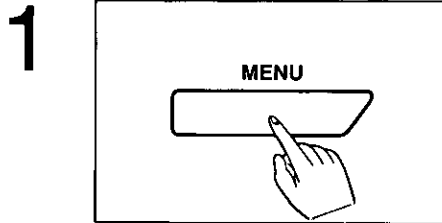

Press the **MENU** button.

PROGRAM[1.DATE 2.TEL
3.SYSTEM 4.REPORT]

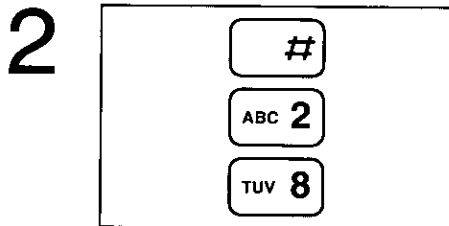

Press #, then press 28.

PRINTER TEST
PRESS START KEY

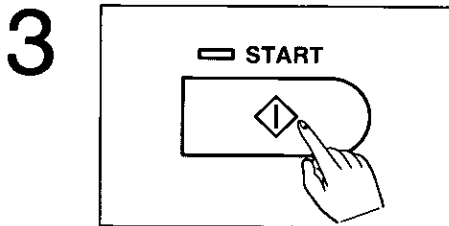

Press the **START** button.

PRINT TEST
EXECUTING

The unit prints the pattern as shown below.

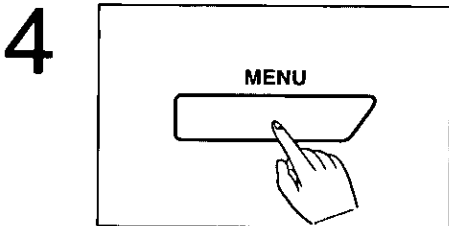

Press the **MENU** button to end the operation.

The display shows the current time.

Sample of test pattern:

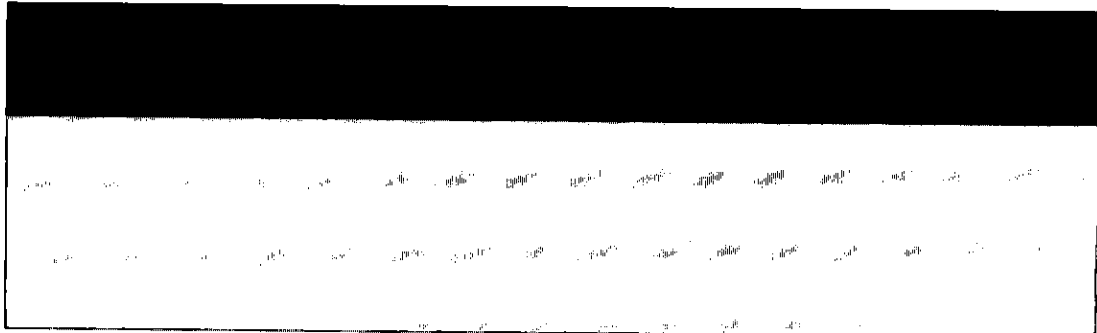

Chapter 8

General Information



Table of contents

Accessory Order Information	8-2
Specifications	8-3
For Users in the United States	8-4
For Users in Canada	8-6
Index	8-8

When the display shows any error message, see page 7-2 for corrective measures.

Accessory Order Information

Replacement parts and accessories are available through your local authorized parts distributor.

Pats No.	Picture	Description	Comment
MC-30 MC-60		Microcassette Tape	For replacement
KX-A101* KX-A106*		Thermal Recording Paper 216 mm x 30 m roll (8 1/2" x 98' roll) KX-A101 = 1/2" core KX-A106 = 1" core	For supplement
KX-A124*		Super Thermal Recording Paper (plaine paper like) 216 mm x 24 m roll (8 1/2" x 80' roll)	For supplement

*These parts numbers are supplied in the United States only. For users in Canada, consult with your palce of purchase or the nearest servicerenter.

Specifications

Type:	Desktop
Applicable Lines:	Public Switched Telephone Network
Document Size:	Max. 216 mm (8½") in width, Max. 600 mm (23⅝") in length
Effective Scanning Width:	Max. 208 mm (8⅜")
Printing Paper Size:	Thermal Paper: 216 mm (letter)×30 m roll (8½"×98' roll) Super Thermal Paper: 216 mm (letter)×24 m roll (8½"×80' roll)
Effective Printing Width:	208 mm (8⅜")
Transmission Time*:	Approx. 30 sec/page (G3 Normal mode) Approx. 15 sec/page (Original mode)
Scanning Density:	Horizontal 8 pels/mm (203 pels/inch) Vertical 3.85 lines/mm (98 lines/inch) Standard 7.7 lines/mm (196 lines/inch) Fine/Halftone 15.4 lines/mm (392 lines/inch) Superfine
Scanner Type:	CCD image sensor
Printer Type:	Thermal printing
Data Compression System:	Modified Huffman (MH), Modified Read (MR)
Modem Speed:	9600/7200/4800/2400 bps; Automatic Fallback
Automatic Document Feeder:	Max. 10 sheets
Temperature Range:	5°–35°C (41°–95°F)
Humidity Range:	45%–85%
Dimensions (H×W×D):	107×379×297 mm (4¼"×14½"×11¾")
Weight:	5.6 kg (12.35 lbs)
Power Consumption:	Approx. 50 W
Power Supply:	AC 120 V, 60 Hz

*Transmission Time: Transmission times apply to text data using ITU-TS No. 1 test chart, between same machine models at maximum modem speed. Transmission times vary in actual usage.

For Users in the United States

If required by the telephone company, inform them of the following.

- FCC Registration No.: (found on the rear side of the unit)
- Ringer Equivalence: (found on the rear side of the unit)

The particular telephone line to which the equipment is connected.

This unit must not be connected to a coin operated line. If you are on a party line, check with your local telephone company.

Ringer Equivalence Number (REN):

This REN is useful in determining the quantity of devices you may connect to your telephone line and still have all of those devices ring when your telephone number is called. In most but not all areas, the sum of the REN's of all devices connected to one line should not exceed five (5.0). To be certain of the number of devices you may connect to your line, as determined by the REN, you should contact your local telephone company to determine the maximum REN for your calling area.

In the event that terminal equipment causes harm to the telephone network, the telephone company should notify the customer, if possible, that service may be stopped. However, where prior notice is impractical, the company may temporarily cease service providing that they:

- a) Promptly notify the customer.
- b) Give the customer an opportunity to correct the problem with their equipment.
- c) Inform the customer of the right to bring a complaint to the Federal Communication Commission pursuant to procedures set out in FCC Rules and Regulations Subpart E of Part 68.

The Telephone Company may make changes in its communications facilities, equipment operations, or procedures where such action is reasonably required in the operation of its business and is not inconsistent with the rules and regulations in FCC Part 68. If such changes can be reasonably expected to render any customer terminal equipment incompatible with telephone company communications facilities, or require modification or alteration of such terminal equipment, or otherwise materially affect its use or performance, the customer shall be given adequate notice in writing, to allow the customer an opportunity to maintain uninterrupted service.

CAUTION:

To assure continued compliance with FCC rules, do not make any unauthorized modifications.

When programming emergency numbers and/or making test calls to emergency numbers:

1. Remain on the line and briefly explain to the dispatcher the reason for the call before hanging up.
2. Perform such activities in the off-peak hours; such as early morning or late evenings.

This telephone provides magnetic coupling to hearing aids.

Note:

This equipment has been tested and found to comply with the limits for a Class B digital device, pursuant to Part 15 of the FCC Rules. These limits are designed to provide reasonable protection against harmful interference in a residential installation. This equipment generates, uses, and can radiate radio frequency energy and, if not installed and used in accordance with the instructions, may cause harmful interference to radio communications. However, there is no guarantee that interference will not occur in a particular installation. If this equipment does cause harmful interference to radio or television reception, which can be determined by turning the equipment off and on, the user is encouraged to try to correct the interference by one or more of the following measures:

- Reorient or relocate the receiving antenna.
- Increase the separation between the equipment and receiver.
- Connect the equipment into an outlet on a circuit different from that to which the receiver is connected.
- Consult the dealer or an experienced radio/TV technician for help.

PANASONIC ANSWERING SYSTEM WITH FACSIMILE Limited Warranty

Panasonic Company, Panasonic Company (West) of America or Panasonic Sales Company (collectively referred to as "PANASONIC"), will repair this product with new or rebuilt parts, free of charge, in the U.S.A. or Puerto Rico for one (1) year from the date of original purchase in the event of a defect in materials or workmanship.

Batteries (when applicable)—New rechargeable batteries in exchange for defective rechargeable batteries for ten (10) days from the date of original purchase. Non-rechargeable batteries are not warranted.

Carry-in or mail-in service in the U.S.A. can be obtained during the warranty period from a Matsushita Services Company (MSC) Factory Servicenter listed in the Servicenter Directory. Carry-in or mail-in service in Puerto Rico can be obtained during the warranty period by calling the telephone numbers listed in the Servicenter Directory.

This warranty is extended only to the original purchaser. A purchase receipt or other proof of date of original purchase will be required before warranty performance is rendered.

This warranty only covers failures due to defects in materials or workmanship which occur during normal use. It does not cover damage which occurs in shipment or failures which are caused by products not supplied by PANASONIC or failures which result from accident, misuse, abuse, neglect, mishandling, misapplication, alteration, faulty installation, modification, or service by anyone other than an MSC Factory Servicenter or an authorized MSC Servicenter or damage that is attributable to Acts of God, including, but not limited to, line surges.

LIMITS AND EXCLUSIONS

There are no express warranties except as listed above.

PANASONIC SHALL NOT BE LIABLE FOR SPECIAL, INCIDENTAL, CONSEQUENTIAL OR PUNITIVE DAMAGES, INCLUDING, WITHOUT LIMITATION, LOSS OF GOODWILL, PROFITS OR REVENUE, LOSS OF USE OF THIS PRODUCT OR ANY ASSOCIATED EQUIPMENT, COST OF SUBSTITUTE EQUIPMENT, DOWNTIME COSTS, OR CLAIMS OF ANY PARTY DEALING WITH BUYER FOR SUCH DAMAGES, RESULTING FROM THE USE OF THIS PRODUCT OR ARISING FROM BREACH OF WARRANTY OR CONTRACT, NEGLIGENCE, OR ANY OTHER LEGAL THEORY.

ALL EXPRESS AND IMPLIED WARRANTIES, INCLUDING THE WARRANTIES OF MERCHANTABILITY AND FITNESS FOR A PARTICULAR PURPOSE, ARE LIMITED TO THE APPLICABLE WARRANTY PERIOD SET FORTH ABOVE.

Some states do not allow the exclusion or limitation of consequential damages, or limitations on how long an implied warranty lasts, so the above exclusions or limitations may not apply to you.

This warranty gives you specific legal rights, and you may also have other rights which vary from state to state.

If a problem with this ANSWERING SYSTEM WITH FACSIMILE develops during the warranty period, you may contact your dealer or the MSC Factory Servicenter or authorized Panasonic Service Dealer. If the problem is not handled to your satisfaction, write to the Panasonic Company Consumer Affairs Division at the address indicated on the Servicenter Directory.

For Users in Canada

SAFETY PRECAUTIONS

This unit may only be connected to electrical outlets that supply 120 V AC.

NOTICE:

The Canadian Department of Communications label identifies certified equipment. This certification means that the equipment meets certain telecommunications network protective, operational and safety requirements. The Department does not guarantee the equipment will operate to the user's satisfaction.

Before installing this equipment, users should ensure that it is permissible to be connected to the facilities of the local telecommunications company. The equipment must also be installed using an acceptable method of connection. In some cases, the company's inside wiring associated with a single line individual service may be extended by means of a certified connector assembly (telephone extension cord). The customer should be aware that compliance with the above conditions may not prevent degradation of service in some situations.

Repairs to certified equipment should be made by an authorized Canadian maintenance facility designated by the supplier. Any repairs or alterations made by the user to this equipment, or equipment malfunctions, may give the telecommunications company cause to request the user to disconnect the equipment.

Users should ensure for their own protection that the electrical ground connections of the power utility, telephone lines and internal metallic water pipe system, if present, are connected together. This precaution may be particularly important in rural areas.

CAUTION:

Users should not attempt to make such connections themselves, but should contact the appropriate electric inspection authority, or electrician.

The Load Number:

(found on the rear side of the unit)

(LN) assigned to each terminal device denotes the percentage of the total load to be connected to a telephone loop which is used by the device, to prevent overloading. The termination on a loop may consist of any combination of devices subject only to the requirement that the total of the Load Numbers of all the devices does not exceed 100.

This digital apparatus does not exceed the Class B limits for radio noise emissions from digital apparatus as set out in the interference-causing equipment standard entitled "Digital Apparatus", ICES-003 of the Department of Communications.

If there is any trouble, disconnect the facsimile from the telephone line, and connect a known working phone. If the known working phone operates properly, have the defective unit repaired by one of the specified Panasonic Factory Servicentres (refer to your dealer). If the known working telephone does not operate properly, consult your telephone company.

Matsushita Electric of Canada Limited
5770 Ambler Drive, Mississauga, Ontario L4W 2T3

Panasonic one year warranty

Matsushita Electric of Canada Limited (also known as MELCA) warrants this product to be free from defects in material and workmanship and agrees to repair or at its option, replace the product for a period of 1 year from the date of original purchase.

This warranty does not apply outside of the boundaries of Canada or to any product which has been improperly installed, subjected to misuse or abuse, shipping damage, or which has been altered or repaired in any way that affects the reliability or detracts from the performance, nor does it cover any product which is used commercially. Rechargeable batteries are warranted for 90 days from date of original purchase. Non-rechargeable batteries are not warranted.

Warranty service

"IN WARRANTY" service can be obtained by delivering your product to the MELCA Factory Servicentre nearest to you (as listed below). A purchase receipt or other proof of date of original purchase will be required before warranty service is performed.

Matsushita Electric of Canada Ltd.
Amherst factory servicentre
134 South Albion Street
Amherst, Nova Scotia
B4H 2X3 (902) 667-4977

Matsushita Electric of Canada Ltd.
Toronto factory servicentre
5770 Ambler Drive
Mississauga, Ontario
L4W 2T3 (416) 624-8447

Matsushita Electric of Canada Ltd.
Montreal factory servicentre
3075, rue Louis A. Amos
Lachine, Quebec
H8T 1C4 (514) 633-8684

Matsushita Electric of Canada Ltd.
Vancouver factory servicentre
13131 Bathgate Place
Richmond, British Columbia
V6V 1Z3 (604) 278-4211

Matsushita Electric of Canada Ltd.
Calgary factory servicentre
6835-8th Street N.E.
Calgary, Alberta
T2E 7H7 (403) 295-3955

Matsushita Electric of Canada Ltd.
Winnipeg factory servicentre
1555 Dublin Avenue
Winnipeg, Manitoba
R3E 3M8 (204) 783-7419

Statutory warranties

The provisions of this additional written warranty are in addition to and not a modification of or subtraction from the statutory warranties and other rights and remedies contained in any applicable legislation.

If you ship the product to a servicentre

Carefully pack and send prepaid, adequately insured and preferably in the original carton. Include details of complaint and proof of date of original purchase.

Index

- A**
- AC Jack 1-5
 - AC Outlet 1-9
 - AC Power Cord 1-2
 - Accessories 1-2
 - Activity Report 6-2
 - Advanced Features 2-3
 - List of 6-8
 - ALARM Indicator 1-7, 1-15, 7-3
 - ALL MESSAGES Button 1-8, 3-12, 3-14
 - ANS/FAX mode 1-18
 - Receiving documents in 3-7
 - ANS/FAX RING COUNT 2-2
 - Selecting 2-12, 2-13
 - Answer back 5-27
 - ANSWERING CONTROL panel 1-17
 - Answering device control panel 1-4
 - AUTO Button 1-7, 4-2, 4-5, 4-7
 - Automatic dialer 4-11
 - Making Voice Calls Using 4-13
 - Transmitting Documents Using 4-11
 - Automatic Dialing 4-2
 - Storing phone numbers for 4-2
 - Automatic redialing feature 3-5, 4-11
- B**
- BACK LID OPEN Lever 1-4, 1-12, 7-7, 7-10
 - Back space 5-25
 - BACK SPACE Key 2-9
 - Basic Features 2-2
 - List of 6-7
- C**
- Call counter 3-12
 - Cassette Compartment 1-5
 - Character Keys 2-8, 2-9
 - CHECK Button 1-8, 1-16, 1-17
 - Cleaning
 - Document feeder unit 7-10
 - Microcassette compartment 7-9
 - Thermal head 7-10
 - CLEAR Button 1-7, 2-4, 4-2, 4-4
 - Combination dialing 5-32
 - Command Keys 2-8, 2-9
 - Copy
 - Making 3-11
 - COPY Button 1-8, 3-11, 5-20
 - Cursor Keys 2-9
- D**
- Date and time 2-5
 - Setting 2-5
 - DAY/NIGHT MODE 2-3
 - Setting 5-33, 5-34
 - Delayed Transmission 5-2, 5-3
 - DELETE Key 2-9
 - Dial Keypad/Character Keys 1-7, 2-8
 - DIALING MODE Selector 1-5, 1-14
 - Setting 1-14
 - Direct Call Station Keys/Character Keys 1-8, 4-2
 - DIRECTORY Button 1-7, 4-2, 4-12
 - Directory card 2-8, 4-2
 - Filling in 4-2
 - DISPLAY CLEAR Key 2-9
 - Diverter 1-2
 - Installing 1-10
 - Document 3-2
 - Acceptable 3-2
 - Clearing jam of 7-6
 - Loading 3-3
 - Receiving 3-6, 3-7, 3-8
 - Transmitting 3-4, 3-5, 4-11, 4-12
 - You cannot send 3-2
 - Document Feeder Tray 1-4
- E**
- Electric Telephone Directory 4-9, 4-14
 - How to use 4-10
 - Making voice calls 4-14
 - Transmitting documents using 4-12
 - Error messages 7-2
 - EXTENSION COPY 2-3
 - Making 5-21, 5-22
- F**
- FAX mode 1-18, 1-19
 - Receiving documents in 3-8
 - FAX RING COUNT 2-2
 - Selecting 2-14
 - FF (Fast Forward) Button 1-8, 3-12
 - FLASH Button 1-8, 5-31
 - FRONT LID OPEN Lever 1-4, 7-6, 7-10
- G**
- Greeting Message 1-16
 - Checking 1-17
 - Recording 1-17
 - Re-recording 5-28
 - Skipping for incoming message recording mode 5-27
- H**
- Handset 1-2, 1-9
 - Handset cord 1-2, 1-9
 - HELP Button 1-7, 2-4
 - Using 2-17, 2-18
 - HELP Function 2-17, 2-18
 - HYPHEN Key 4-2, 4-3, 4-5

I			
ICM ERASE Button	1-8, 3-12		
Incoming message	3-13, 3-14		
INSERT Key	2-9		
Installation connections	1-9		
J			
JOURNAL AUTO PRINT	2-3		
Setting	6-3		
JOURNAL Report	6-2		
Printing manually	6-4		
JUNK MAIL PROHIBITOR	2-3		
Turning on	4-9		
JUNK MAIL PROHIBITOR ID	4-9		
L			
LCD (Liquid Crystal Display)	1-7		
LIGHT ORIGINAL	3-3		
LIGHT ORIGINAL Button and Indicator/◀ Key	1-7		
LINE Jack	1-5		
Connect to	1-9		
List of Stored Phone Numbers	6-5		
Sample of	6-5		
Location of Controls	1-4		
LOGO POSITION	2-3		
Setting	5-18		
Lower guide plate	1-12		
M			
Maintenance	7-9		
Memo message	3-15		
Recording	3-15		
Memory playback	5-24		
MEMO/2WAY REC Button	1-8, 3-15, 3-16		
MENU Button	1-7, 2-4, 4-2		
MESSAGE ALERT	2-3		
Setting	5-29		
MIC (Microphone)	1-16		
Microcassette compartment	1-5		
Cleaning	7-9		
Microcassette tape	1-2		
Installing	1-11		
Taking off	1-11		
MUTE Button and Indicator	1-8		
N			
Network Communication	5-4		
NETWORK PASSCODE	2-3		
Programming	5-6		
NEW MESSAGES Button	1-8, 3-12, 3-13		
O			
One touch dialing	4-3		
Storing phone numbers for	4-3		
OVERSEAS/TRANSMIT SETTING			
Button and Indicators	1-7, 5-16, 5-17		
P			
PAPER OUT Indicator	1-7, 1-13, 1-15		
Paper roll holders	1-2, 1-13		
Paper rollers	7-10		
PAPER SAVE FUNCTION	2-3		
Setting	5-19, 5-20		
PAUSE Button	1-8, 5-32		
Pinch roller	7-9		
POWER Switch	1-5		
Turning on	1-15		
PRINT ADVANCED FEATURE LIST	2-2		
PRINT TRANSMISSION REPORT	2-2		
Changing	2-11		
Sample of	2-10		
PRINTER TEST	2-3, 7-11		
R			
REC Button	1-8, 1-16, 1-17		
RECEIVE MODE	1-18, 3-7		
ANS/FAX mode	1-18, 3-7		
FAX mode	1-18, 1-19, 3-8		
TEL mode	1-18, 1-19		
TEL/FAX mode	1-18, 1-19, 3-8		
RECEIVE MODE Button and Indicators	1-7, 1-18		
RECEIVER VOLUME Selector	1-5		
Setting	1-14		
Receiving Tray	1-2, 1-4		
Installing	1-10		
Reception			
Automatic	3-7		
Interrupting	3-6		
Manual	3-6		
Recording paper	1-2		
Clearing jam of	7-7		
Installing	1-12, 1-13		
RECORDING TIME FOR ANS	2-2		
Changing	2-15		
REDIAL Button	1-8, 3-18		
Redialing	3-18		
Remote control functions	5-23		
Answer back	5-27		
Back space and skip forward	5-25		
Playing back all messages	5-24		
Playing back newly recorded messages	5-24		
Recording a marker message	5-25		
Re-recording a greeting message	5-28		
Resetting tape for future messages	5-26		
Skipping the greeting message	5-27		
REMOTE FAX ACTIVATION CODE	2-3		
Changing	5-13		
Remote Fax Receiving	5-12		
Using an Extension Phone	5-12		
REMOTE ANS ID	2-2, 5-23, 5-24		
Setting the code for	2-16		
Resetting setup features	5-36		
Resetting tape	5-26		

RESOLUTION	3-3
Setting	3-3
RESOLUTION Button and Indicators/▶ Key	1-7
REW (Rewind) Button	1-8, 3-12, 3-13
RING PATTERN DETECTION	2-3, 5-14, 5-15
RINGER OFF	2-12
RINGER Volume Selector	1-5
Setting	1-14
Rotary pulse dial service (PULSE)	1-14
RX PASSCODE CHECK	2-3, 5-4, 5-5
Turning on	5-8

S

SECRET Key	4-2, 4-7
Secret Phone Numbers	4-7
Storing	4-7
SET Button	1-7, 2-4, 4-2
SET DATE	2-2
SET DEFAULT	2-3
SILENT FAX RECOGNITION RING	2-3
Setting	5-35
Skip forward	5-25
SP-PHONE (VOICE STDBY) Button	
and Indicator	1-8, 5-30
SPACE Key	2-9
Specifications	8-3
Speed dialing	4-5
Station numbers for	4-2
Storing phone numbers for	4-5
START Button and Indicator	1-8
STOP (⊖) Button	1-8, 4-2
STOP (■) Button	1-8, 3-12
System setup features	2-2

T

TEL mode	1-18, 1-19
TEL/FAX mode	1-18, 1-19
Receiving documents in	3-8
Telephone conversation	3-16
Recording	3-16
Telephone line cord	1-2
TELEPHONE NUMBER LIST	6-5
Printing	6-6
Temporary tone dialing	5-31
Test pattern	7-11
Thermal head	7-10
Cleaning	7-10
TO HANDSET Jack	1-5
Connect to	1-9
Toll Saver	2-12, 2-13
TONE Button	1-7, 5-31
Touch tone service (TONE)	1-14
Transmission	
Manual	3-4
Report	2-10
Troubleshooting	7-2
TX PASSCODE CHECK	2-3, 5-4, 5-5
Turning on	5-7

U

Upper guide plate	1-12
-------------------	------

V

Voice Contact	5-30
Initiating	5-30
Receiving a request for	5-30
VOLUME Control	1-5, 1-16
VOX	1-16, 2-15

X

XMT (transmission) REPORT	2-10
---------------------------	------

Y

YOUR LOGO	2-2, 2-6
Setting	2-6, 2-7
YOUR TELEPHONE NUMBER	2-2, 2-6
Setting	2-6, 2-7

# Button	2-7
* Button	2-7, 5-31
 Indicator	1-7, 3-12, 3-13
▲ Button	1-7
▼ Button	1-7
◀ Key	2-9
▶ Key	2-9

FAX CORRESPONDENCE

TO: _____ DATE: _____

FROM: _____ OUR TEL. NO.: _____

We would like to take this opportunity to introduce you to our Panasonic telephone answering device with facsimile. Our unit will work as a facsimile, an answering device and a standard telephone, so you can send both documents and voice-messages on the same call.

Transmitting a voice-message and a document

1. Dial our phone number. Our unit will play the greeting message.
2. Leave your message after the long beep.
3. Press "*" (asterisk) button or enter the JUNK MAIL PROHIBITOR ID if it is written on this paper after recording your incoming message.
Our unit will switch to the facsimile mode and a fax tone sounds.
4. Start transmission to send a fax after hearing the fax tone.

Transmitting a document only

1. Dial our phone number. Our unit will play the greeting message.
2. Press your "*" button or enter the JUNK MAIL PROHIBITOR ID if it is written on this paper, while the greeting message is being played.
3. Start transmission to send a fax after hearing the fax tone.

Our JUNK MAIL PROHIBITOR ID is _____.

If you call from a rotary (pulse) phone:

Transmitting a document only

1. Dial our phone number.
Our unit will play the greeting message.
2. Start transmission to send a fax while the greeting message is being played.

Transmitting a document and a voice-message

1. Dial our phone number.
Our unit will play the greeting message.
2. Start transmission to send a fax.
3. Make a call reservation (e.g. ...lift the handset) during transmission of your document.
4. Leave your message after the long beep following the greeting message.

NOTE:

If our unit requests the JUNK MAIL PROHIBITOR ID, transmission cannot be done from a rotary phone.

If our unit is in a fax mode, the greeting message is not played and a fax tone sounds. You cannot talk to us, and fax reception only is available.

SPEED DIALER LIST

CODE	NAME	CODE	NAME	CODE	NAME	CODE	NAME	CODE	NAME
00		25		50		75			
01		26		51		76			
02		27		52		77			
03		28		53		78			
04		29		54		79			
05		30		55		80			
06		31		56		81			
07		32		57		82			
08		33		58		83			
09		34		59		84			
10		35		60		85			
11		36		61		86			
12		37		62		87			
13		38		63		88			
14		39		64		89			
15		40		65		90			
16		41		66		91			
17		42		67		92			
18		43		68		93			
19		44		69		94			
20		45		70		95			
21		46		71		96			
22		47		72		97			
23		48		73		98			
24		49		74		99			

Transmitting documents using speed dialing:

Insert the documents FACE DOWN. Press the AUTO button, then enter 2-digit number (00 through 99).

SPEED DIALER LIST

CODE	NAME	CODE	NAME	CODE	NAME	CODE	NAME
00		25		50		75	
01		26		51		76	
02		27		52		77	
03		28		53		78	
04		29		54		79	
05		30		55		80	
06		31		56		81	
07		32		57		82	
08		33		58		83	
09		34		59		84	
10		35		60		85	
11		36		61		86	
12		37		62		87	
13		38		63		88	
14		39		64		89	
15		40		65		90	
16		41		66		91	
17		42		67		92	
18		43		68		93	
19		44		69		94	
20		45		70		95	
21		46		71		96	
22		47		72		97	
23		48		73		98	
24		49		74		99	

Transmitting documents using speed dialing:
 Insert the documents FACE DOWN. Press the AUTO button, then enter 2-digit number (00 through 99).

OPERATION FROM TONE PHONE

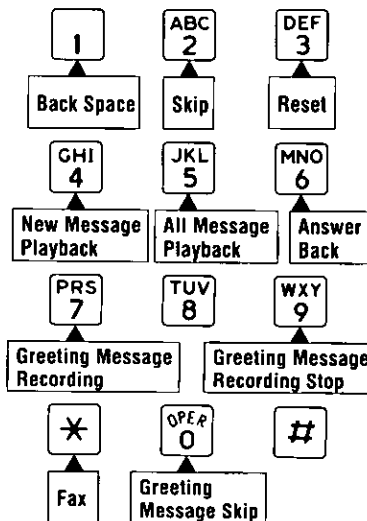

Call your unit.

Press remote code no. _____

- To play back new messages, press "4".
- To play back all messages, press "5".
- For back space, press "1".
- For skip forward, press "2".
- To reset the tape, press "3".
- To record your own message, speak after hearing 2 beeps.
- To save the messages, hang up after playback.

Call your unit. → To skip greeting message, press "0".

Press remote code no. ____ → For Answer Back, press "6".

To re-record greeting message,
1. Press "7".
2. Speak after the long beep (up to 16 seconds).
3. When finished, press "9".

● **To set the ANS/FAX mode,** call your unit and wait for 15 rings. The unit will answer, then hang up.

● **To send the document,** press *. When the beep (fax tone) is heard, start transmission.

● When you press any button, press firmly.

Servicenter Directory (For the United States Only)

PRODUCT INFORMATION • OPERATION ASSISTANCE • LITERATURE REQUESTS • DEALER LOCATIONS

DIAL TOLL FREE: 1-800-HELP-FAX

Customer Service Center 2F-3, One Panasonic Way, Secaucus, NJ 07094 (Headquarters)
201-348-9090 (9:00am–8:00pm Monday–Friday, EST)

SERVICE INQUIRIES

Regional Customer Care Department

NORTHEAST

2221 Cabot Boulevard West
Suite A
Langhorne, PA 19047
215-741-0676

Covers:

CT, DE, ME, MD, MA,
NH, NJ, NY, PA, RI, VT,
VA, DC, WV, Eastern OH

MIDWEST

1703 North Randall Road
Elgin, IL 60123
708-468-5530

Covers:

IL, IN, IA, KS, KY, MI,
MN, MO, NE, ND, SD,
WI, Western OH

WESTERN

6550 Katella Avenue
Cypress, CA 90630
714-373-7440

Covers:

AK, AZ, CA, CO, ID,
MT, NV, NM, OR, UT,
WA, WY, HI

SOUTHERN

1854 Shackelford Court
Suite 4105
Norcross, GA 30093
404-717-6860

Covers:

AL, AR, FL, GA, LA,
MS, NC, OK, SC, TN, TX

PRODUCT SERVICE

Factory Servicenters

CALIFORNIA

6550 Katella Avenue
Cypress, CA 90630
714-373-7425

800 Dubuque Avenue
So. San Francisco,
CA 94080

415-871-6373

20201 Sherman Way
Suite 102

Canoga Park, CA 91306

818-709-1775

3878 Ruffin Road

Suite A

San Diego, CA 92123

619-560-9200

COLORADO

1640 South Abilene Suite D

Aurora, CO 80012

303-752-2024

FLORIDA

3700 North 29th Avenue

Suite 102

Hollywood, FL 33020

305-925-2880

4710 Eisenhower

Boulevard Suite A1

Tampa, FL 33634

813-884-4746

GEORGIA

4245 International Boulevard

Suite C

Norcross, GA 30093

404-717-6880

HAWAII

99-859 Iwaiwa Street

Aiea, Hawaii 96701

808-488-1996

ILLINOIS

*1703 North Randall Road

Elgin, IL 60123

708-468-5466

*9401 W. Grand Avenue

Franklin Park, IL 60131

708-452-2580

9060 Golf Road

Niles, IL 60714

708-299-1700

MARYLAND

Sulphur Springs

Business Center

1638 Sulphur Springs Road

Baltimore, MD 21227

410-242-2607

MASSACHUSETTS

60 Glacier Drive Suite G

Westwood, MA 02090

617-329-4280

MICHIGAN

37048 Van Dyke Avenue

Sterling Heights, MI 48312

313-939-2060

MINNESOTA

7850-12th Avenue South

Airport Business Center

Bloomington, MN 55425

612-854-8624

MISSOURI

11982 Dorsett Road

Maryland Heights, MO 63043

314-739-5301

OHIO

1196 W. Kemper Road

Cincinnati, OH 45240

513-851-4180

PENNSYLVANIA

2221 Cabot Boulevard West

Suite B

Langhorne, PA 19047

215-741-0661

Campbell's Run

Business Center

500 Business Center Drive

Pittsburgh, PA 15205

412-788-2174

*pick-up/drop-off only

TENNESSEE

919-8th Avenue South

Nashville, TN 37203

615-244-4434

TEXAS

7420 Harwin Drive

Houston, TX 77036

713-781-1528

13615 Welch Road Suite 101

Farmers Branch, TX 75244

214-385-1975

WASHINGTON

20425-84th Avenue South

Kent, WA 98032

206-872-7922

Service in Puerto Rico

**Matsushita Electric
of Puerto Rico, Inc.
Panasonic Sales Company/
Factory Servicenter**

San Gabriel Industrial Park
65th Infantry Avenue KM 9.5
Carolina, Puerto Rico 00630
809-750-5135

AUTHORIZED SERVICENTERS • PARTS DISTRIBUTOR LOCATIONS

To locate an independent authorized servicenter or parts distributor in your area, within the USA dial toll free
1-800-545-2672, 24 hours a day, 7 days a week.

ACCESSORY PURCHASES

1-800-332-5368 (Consumer Orders Only)

Matsushita Services Company Box 01, 545 Tollgate Road Suite C, Elgin, IL 60123

(8:00am–7:30pm Monday–Thursday; 8:00am–5:00pm Friday; 9:00am–12:30pm Saturday; CST)

(Visa, Mastercard, Discover card, Check or Money Order)

Panasonic Company,
Division of Matsushita Electric Corporation of America
One Panasonic Way, Secaucus, New Jersey 07094

Panasonic Company (West) of America,
Division of Matsushita Electric Corporation of America
6550 Katella Avenue, Cypress, California 90630

Panasonic Sales Company ("PSC"),
Division of Matsushita Electric of Puerto Rico, Inc.
San Gabriel Industrial Park, 65th Infantry Avenue, KM 9.5, Carolina, Puerto Rico 00630

Matsushita Electric of Canada Limited
5770 Ambler Drive, Mississauga, Ontario, L4W 2T3
